

# **Color Theory – Part 5**

Visual and Instrumental Evaluation

# Color Theory – Part 5

## Visual and Instrumental Evaluation

The image is a collage illustrating color measurement concepts and equipment. It features several diagrams and photographs:

- Measurement geometries:** Four diagrams show different light source and sensor configurations:
  - 0 / 45°:** Light source at 0°, sensor at 45°.
  - 45° / 0°:** Light source at 45°, sensor at 0°.
  - d / 8°:** Light source at 8°, sensor at d°.
  - d / 8°:** Light source at d°, sensor at 8°.
- Integrating Sphere:** A central diagram labeled "Detector", "Source", and "Sphere" showing light rays reflecting inside a sphere. The geometry is labeled  $d/8^\circ$ .
- Colorimeter:** A photograph of a person in a white lab coat using a Datacolor 500 colorimeter. A computer monitor in the background displays a software interface with various graphs and data tables.
- Color Matching App:** A smartphone screen showing a "Color Matches" app interface with a search bar and results for "Bosporus".
- ColorReader PRO:** A vertical, cylindrical color measurement device labeled "ColorReader PRO by datacolor".
- Visual Evaluation:** A photograph of a person holding a color chart in a light booth, and another photograph of a person using a colorimeter on a surface.

# Review - A Colorimetric Description

*Defining a numerical system for color perception*

We have described the visual color perception process by showing how the light source, object and observer are together responsible for color perception.

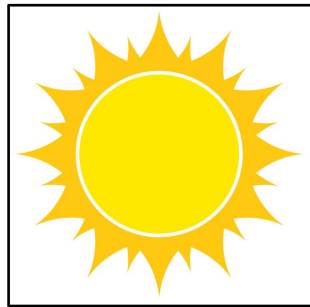

Natural Daylight

**X**

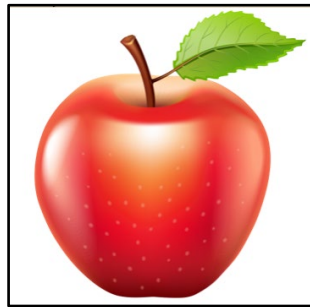

Object (Apple)

**X**



Human Observer

**=**

**Color Perception**

With the Standard Observer, we can now develop a numerical specification:

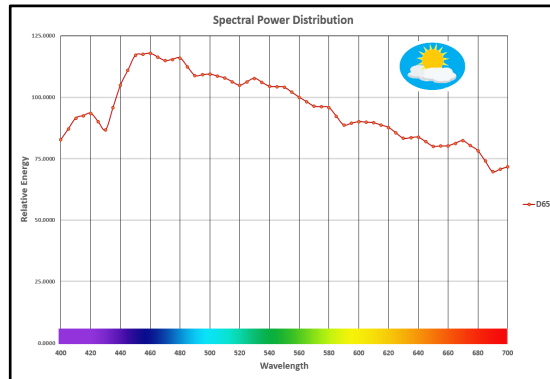

Daylight Illuminant  
Numerical Data

**X**

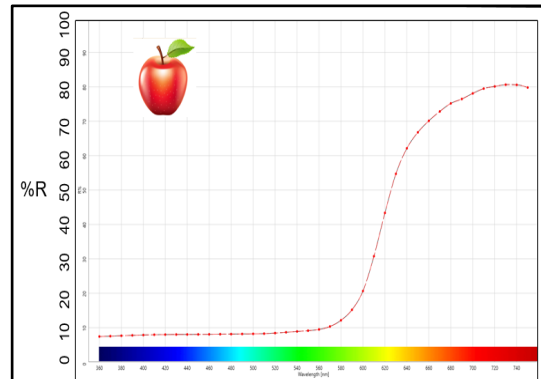

Reflectance Curve  
Numerical Data

**X**

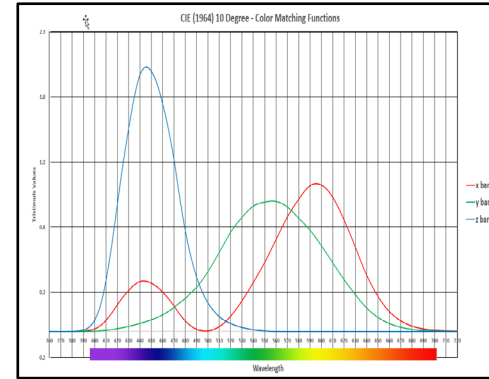

CIE Standard Observer  
Numerical Data

**=**

**Colorimetric Description**

# Review - What the XYZ Means

*Having the Standard Observer Match the Apple Under Daylight Illumination* Academy

**X = 58.1**    **Y = 36.0**    **Z = 5.9**

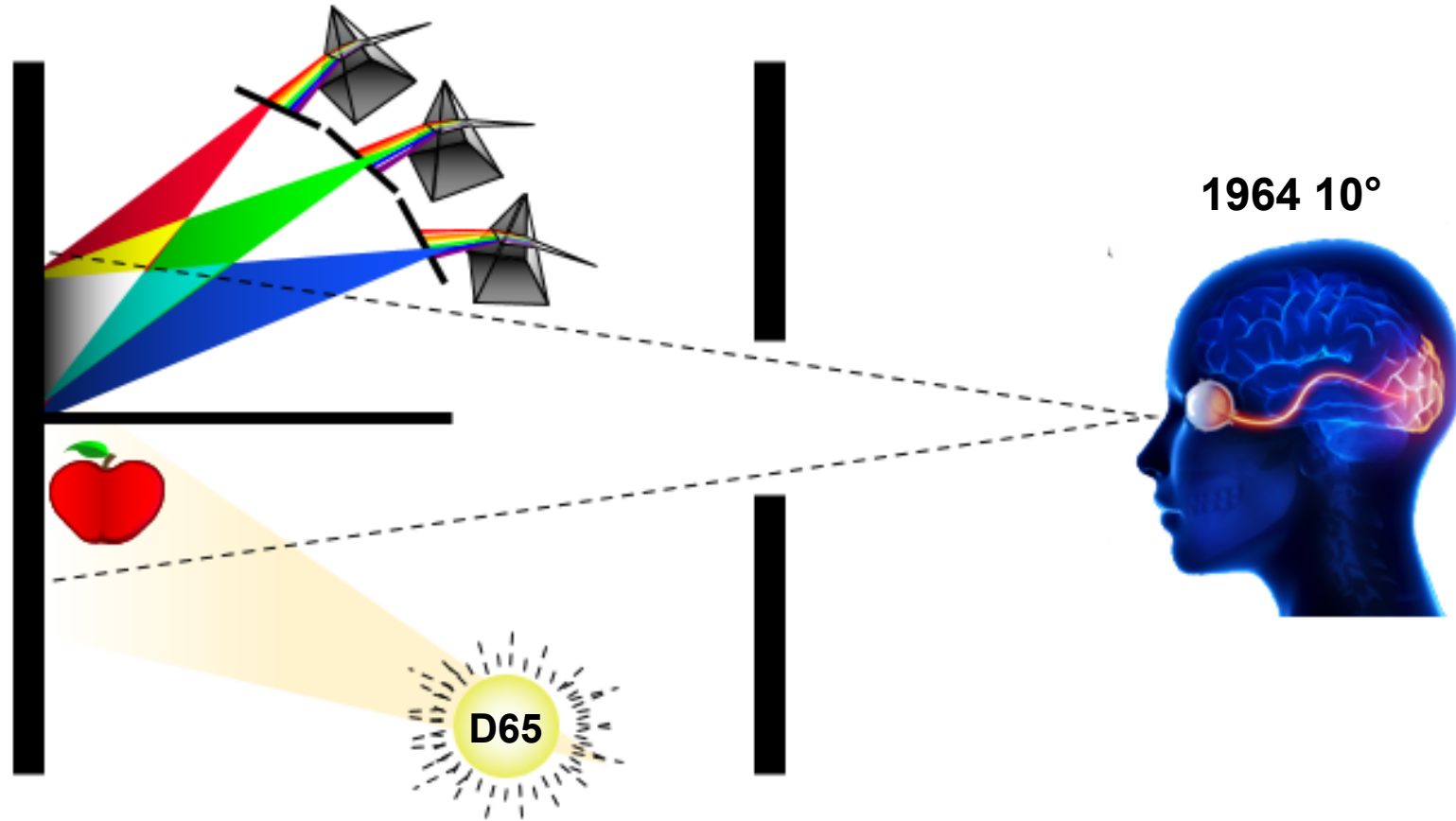

# Review - Metamerism

## Simple Gray and Complex Gray

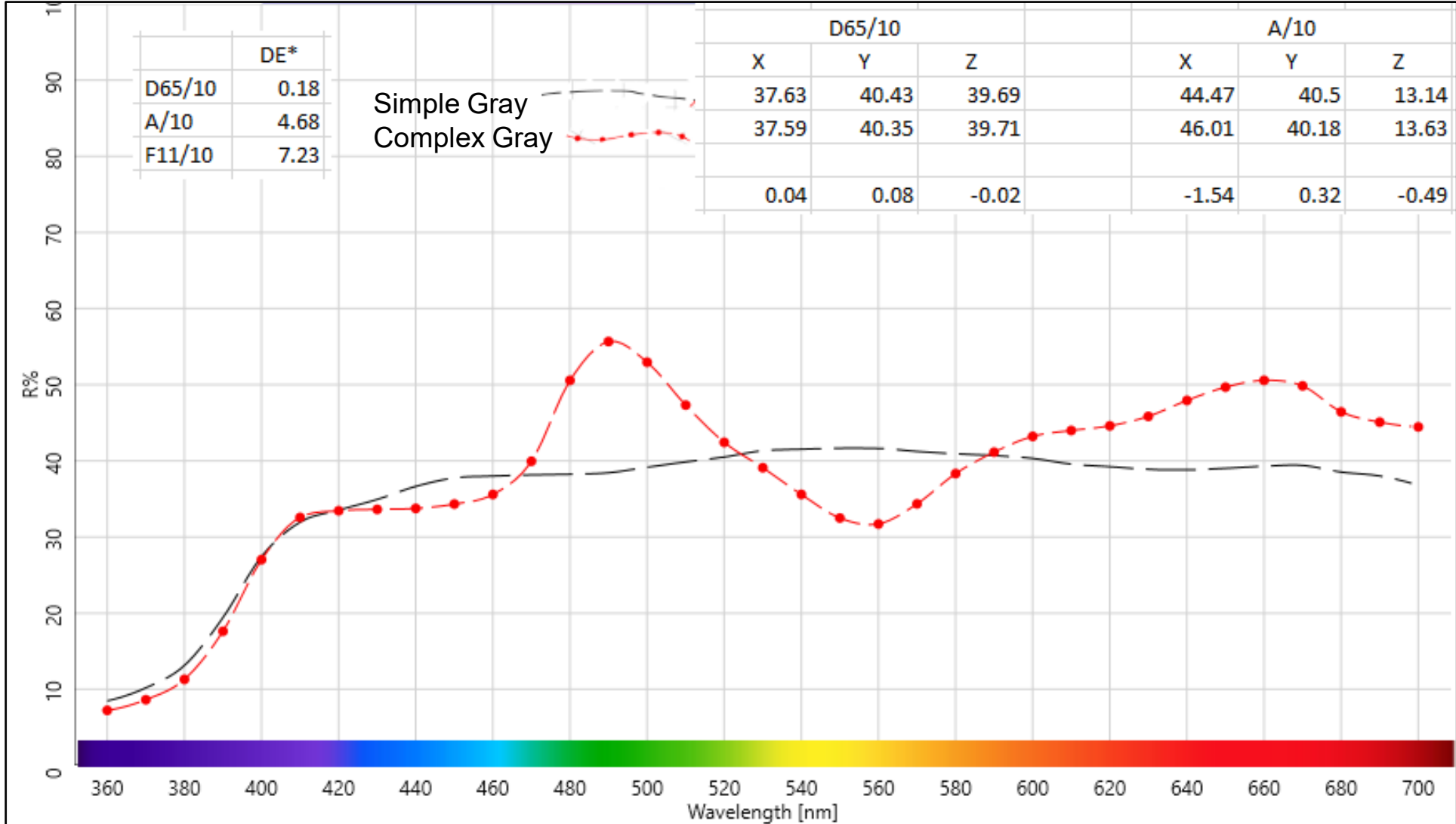

# Review - CIELAB

3 Dimensions of Color – Hue, Chroma, Lightness

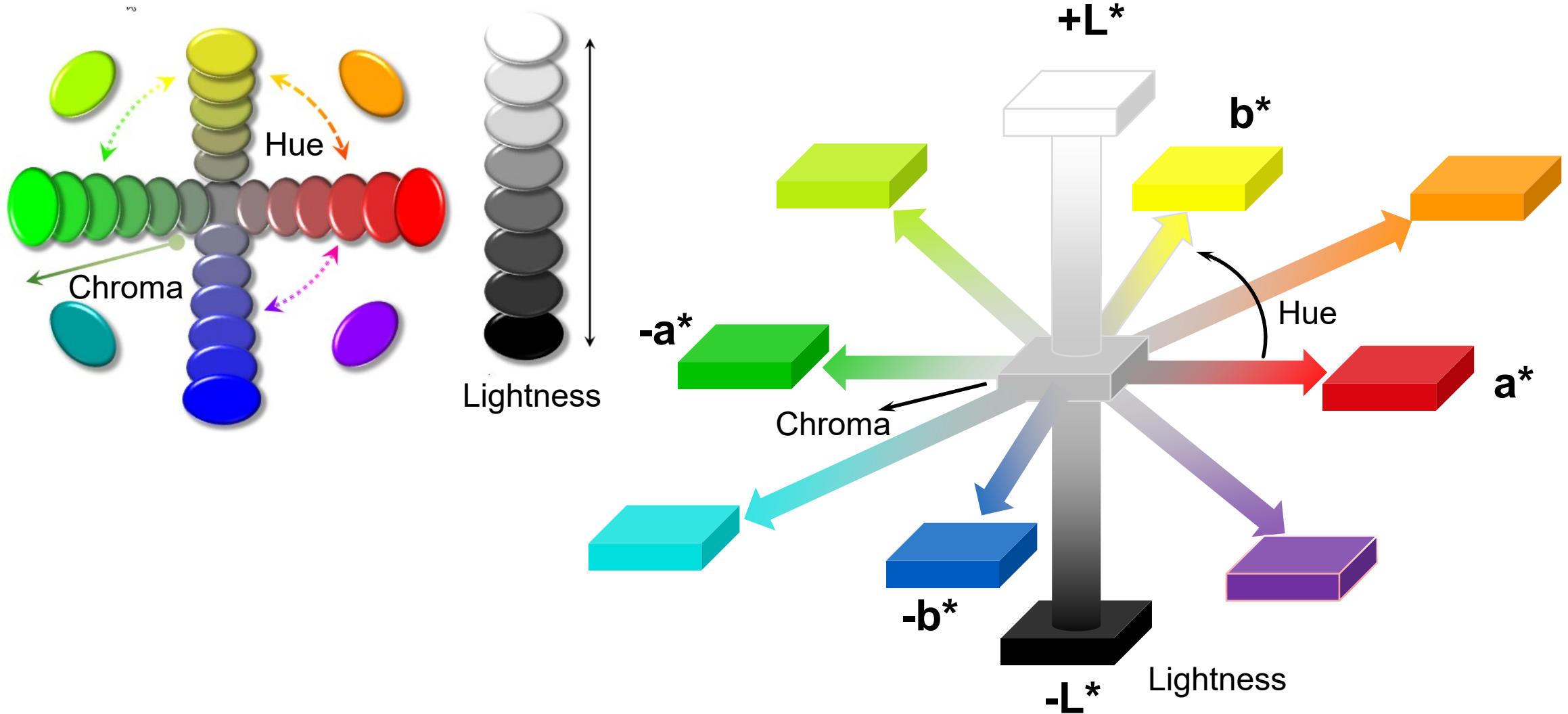



# Review - CIELAB Color Difference

Red Apple 1 and Red Apple 2



Red Apple 1

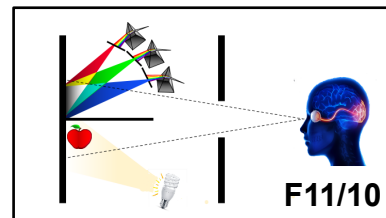
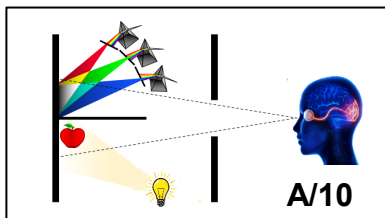
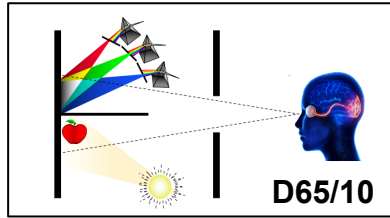

Current Illumi	Std. Name	Std. CIE X	Std. CIE Y	Std. CIE Z	Std. CIE L	Std. CIE a	Std. CIE b	Std. CIE C	Std. CIE h
D65 10 Deg	Red Apple 1	21.65	13.60	9.29	43.65	48.50	14.38	50.58	16.51
A 10 Deg		34.21	18.83	3.06	50.49	51.01	26.02	57.26	27.03
F11 10 Deg		26.83	15.91	5.58	46.86	47.48	20.42	51.68	23.27



Red Apple 2

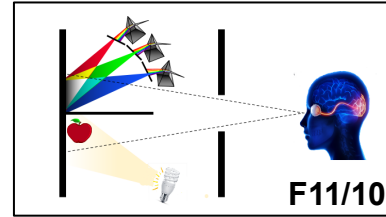
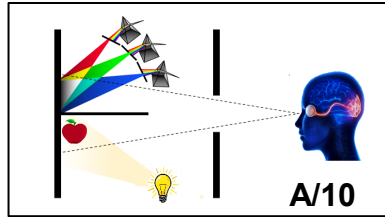
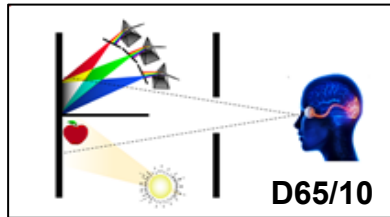

Current Illumi	Batch Name	Batch CIE X	Batch CIE Y	Batch CIE Z	Batch CIE L	Batch CIE a	Batch CIE b	Batch CIE C	Batch CIE h
D65 10 Deg	Red Apple 2	24.30	16.28	11.16	47.34	44.58	15.16	47.09	18.78
A 10 Deg		37.04	21.62	3.62	53.62	46.57	26.30	53.49	29.45
F11 10 Deg		30.77	19.11	6.90	50.82	45.29	20.79	49.84	24.66

CIELAB Color Difference – DL\*, Da\*, Db\*, DC\*, DH\*, DE\*

Current Illumi	Batch Name	CIE DL	CIE Da	CIE Db	CIE DC	CIE DH	CIE DE
D65 10 Deg	Red Apple 2	3.69	-3.92	0.78	-3.50	1.93	5.44
A 10 Deg		3.13	-4.44	0.28	-3.78	2.34	5.44
F11 10 Deg		3.96	-2.19	0.37	-1.85	1.23	4.54

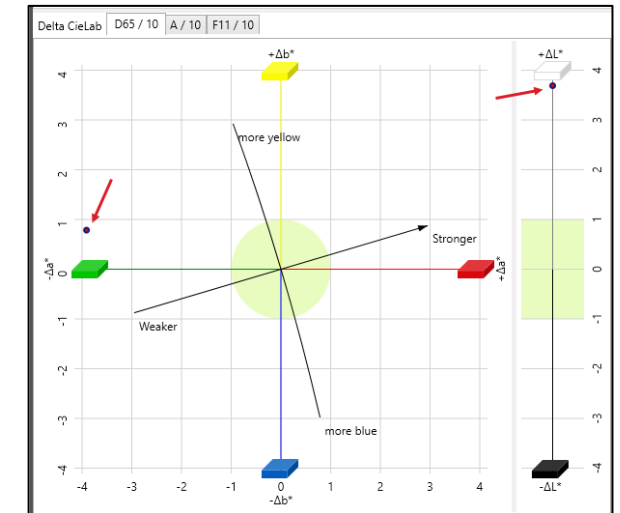
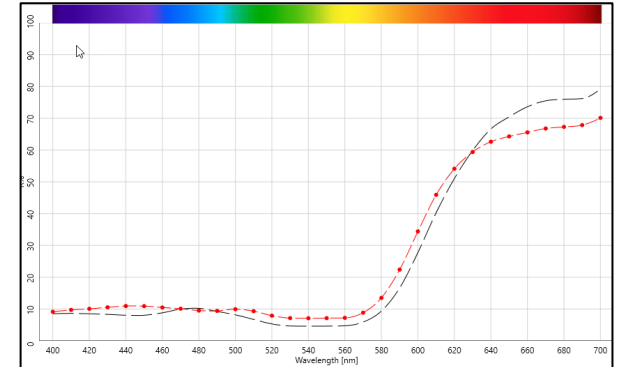

# Review - Color Tolerances

## *Acceptability versus Perceptibility*

Perceptibility defines a just-noticeable difference between a standard and a batch.

Acceptability is the largest acceptable difference between a standard and a batch.

Color tolerances are the colorimetric limits that define when a product is acceptable.

Realistic tolerances are usually based on the maximum acceptable color difference rather than on a minimum perceptible difference. A color tolerance is the amount of color difference or variation that is commercially acceptable. Color tolerances will vary across industries. A good tolerance represents a compromise between the capability of the process and the customer's requirements.

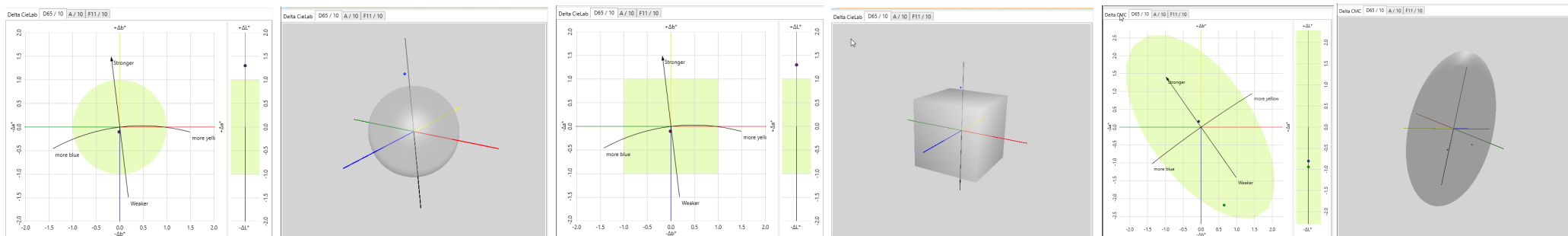



The appearance of an object is the result of a complex interaction of light with objects, the absorption and scattering properties of the objects which modify light, the ability of the eye to gather light energy and for the brain to interpret it. In order to develop an instrumental evaluation process that will agree with a visual evaluation process, we should separate general “appearance” attributes into both color and appearance.

**Color** is what a person perceives. As we stated in our first webinar, color is a perception by an observer of light which has been modified by an object. Most of our discussion to this point has been on understanding color in this aspect.

**Appearance** is what we see. It is not just the color of an object but all the things that influence the visual interpretation by the brain. These include gloss, texture, shape, opacity, transparency and many more. Our interpretation of objects is affected by the illumination, the viewing conditions, color vision deficiencies, what surrounds the objects, fluorescence, the psychological state of the viewer and the surface quality of the objects.

Product quality will depend on control of both color and appearance attributes. The measurable attributes of appearance can be separated into color (hue, chroma and lightness) and geometry (gloss, haze, etc.) These are all equally important in determining color acceptability and quality in a product.

# Successful Color Evaluation

*What's Required?*

- Observers trained to “see” the same.
- Consistent viewing conditions - illumination and viewing angle.
- A common language to express and categorize colors.
- Motivation to do this, all the time.

# Trained Observers

- Observers trained to “see” the same

To perform color evaluations effectively requires the individual to have no color deficiencies as they not only need to see the differences, they also need to communicate them to other people.

The two most popular tests for color discrimination and color blindness are the Farnsworth-Munsell 100 Hue test and the Ishihara test

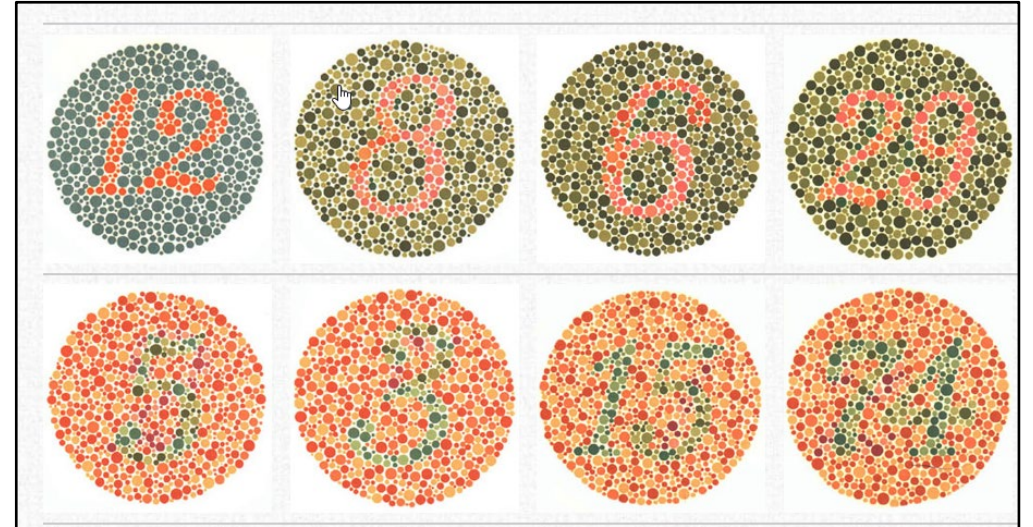

# Light Booth

*Consistent Viewing Conditions*

Light Booth - Consistent viewing conditions, illumination and viewing angle.

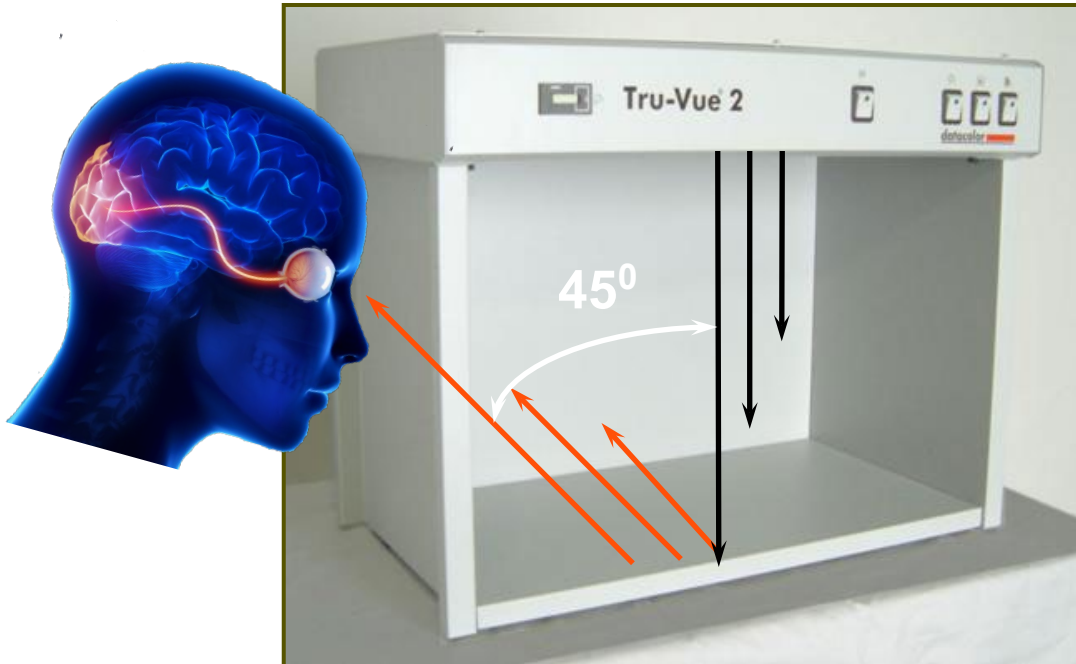

**Primary Light Source**  
**Secondary Light Sources**

**High Illumination**

**Matte, mid-tone gray interior**

**45-degree angle of observation**

## **Color Order System and Difference Scales**

Example could be to use CIELAB with  $DL^*$ ,  $Da^*$ ,  $Db^*$ ,  $DC^*$ ,  $DH^*$ , and  $DE^*$  Difference

## **Light Sources**

Select the same 3 light sources for visual and numerical evaluation. ie D65/10, A/10, F11/10

## **Sample orientation relative to viewer and light source**

Place sample and standard in same position for best viewing.

## **Controlled Temperature and Humidity**

Maintain normal environmental conditions.

## **Backgrounds (Sample Backing)**

Use the same background especially for transparent or translucent samples.

## **Known procedures for sample preparation**

Sample prep must be repeatable and well documented (SOP)

# Spectrophotometer

*Integrating Sphere*

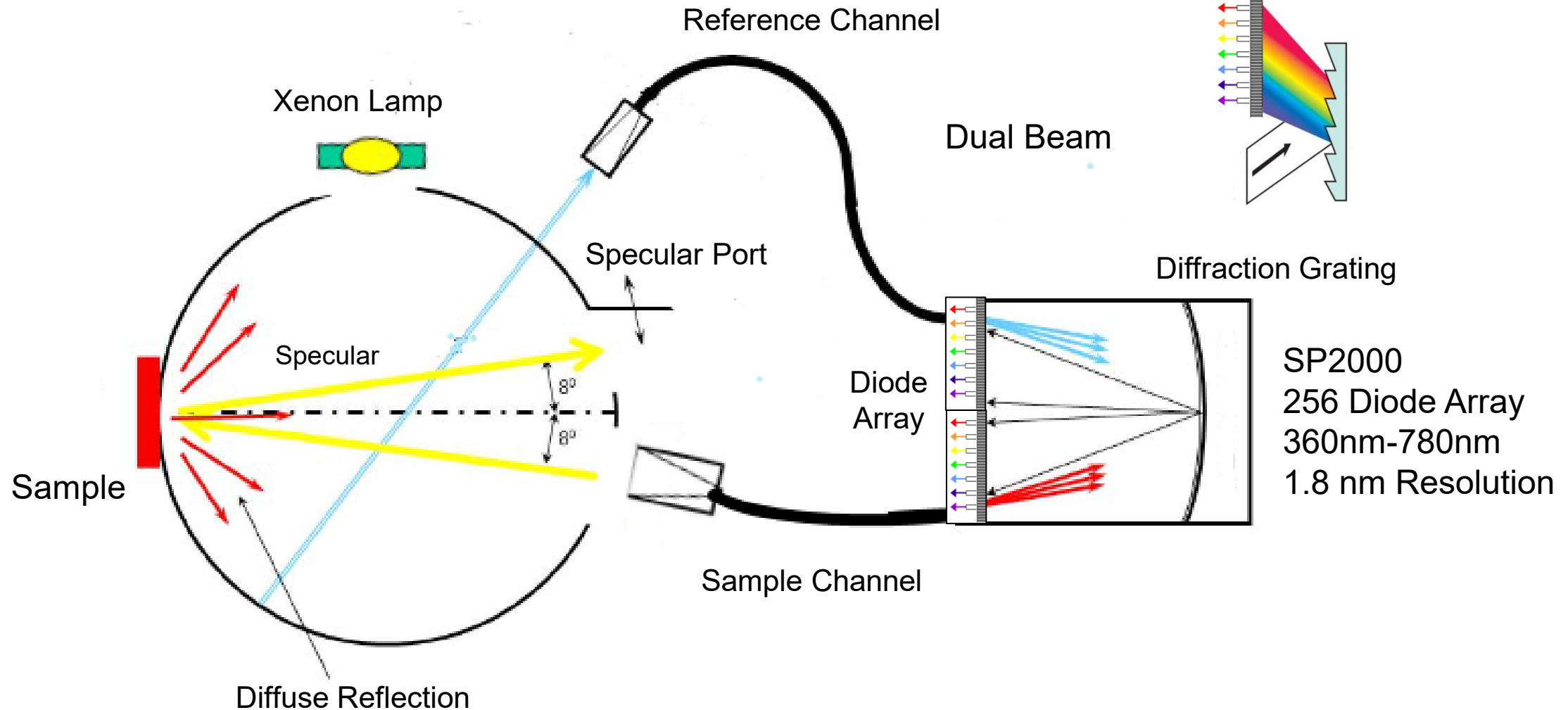



# Spectrophotometer

*d/0 – Diffuse / Normal*      *0/d - Normal / Diffuse*

**d/0**

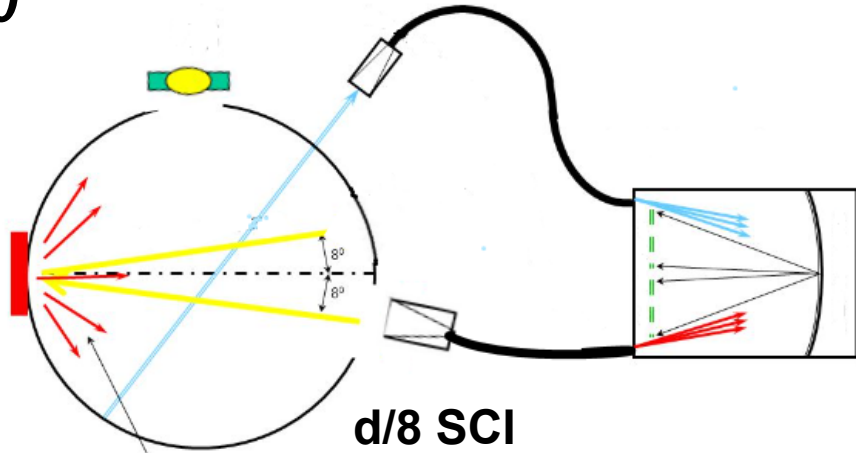

**d/8 SCI**  
Specular Component Included

**d/0**

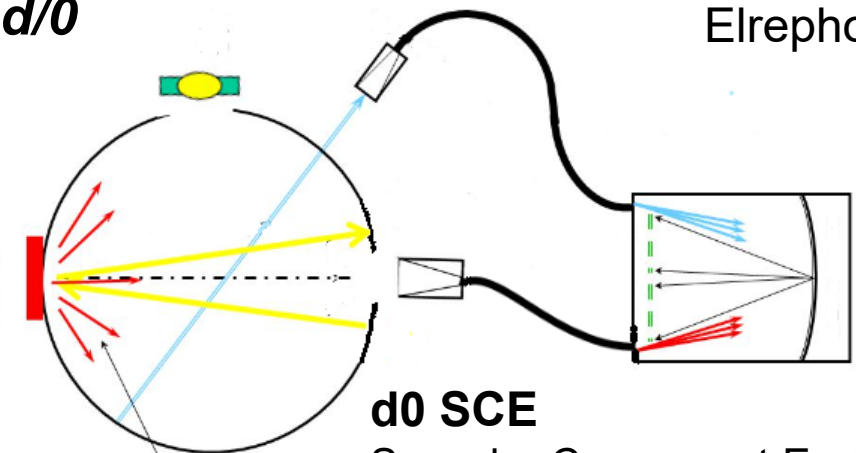

**d0 SCE**  
Specular Component Excluded

Elrepho

**d/0**

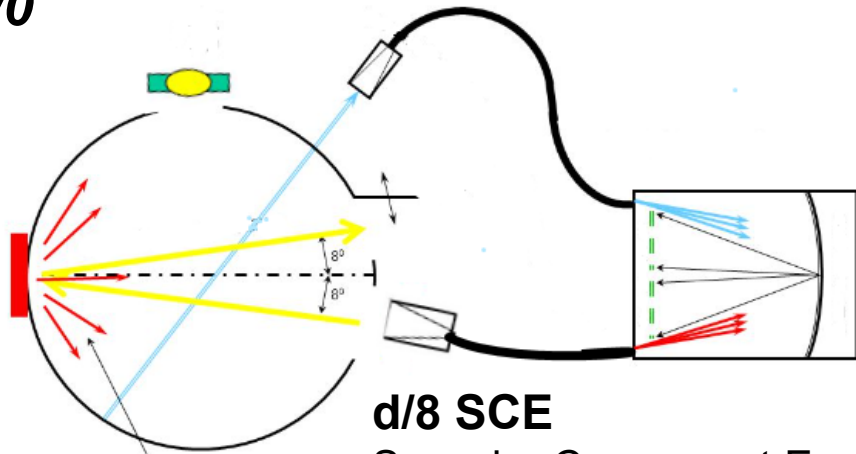

**d/8 SCE**  
Specular Component Excluded

**0/d**

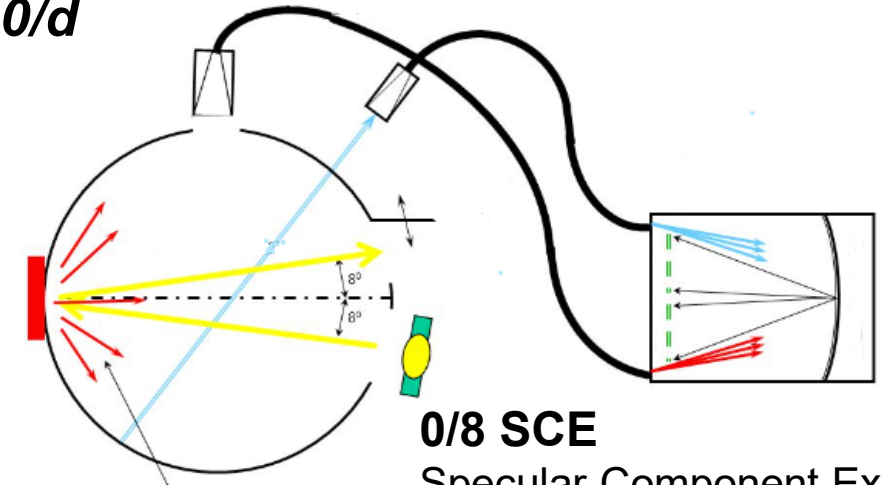

**0/8 SCE**  
Specular Component Excluded

# Spectrophotometer

45/0 0/45 45/0 Circumferential

**45/0**

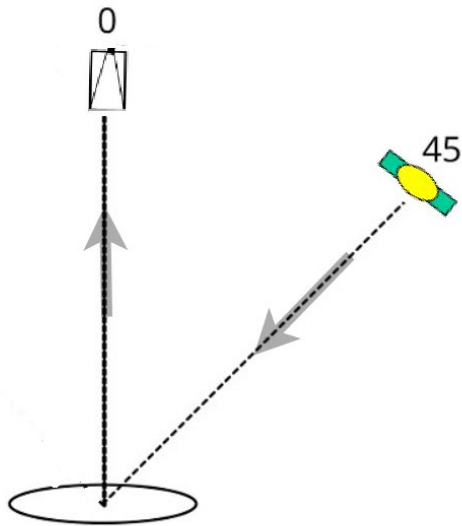

**0/45**

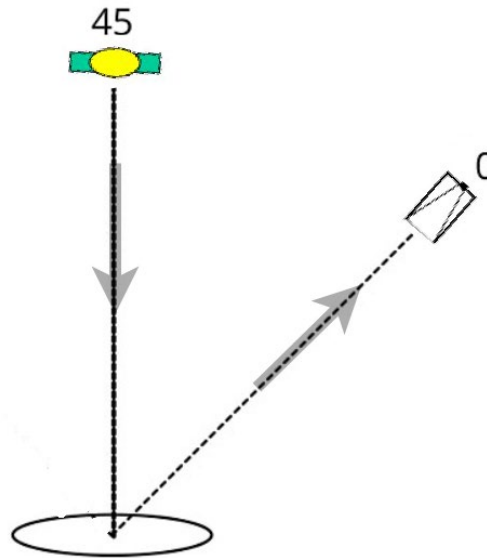

**45/0**  
Circumferential

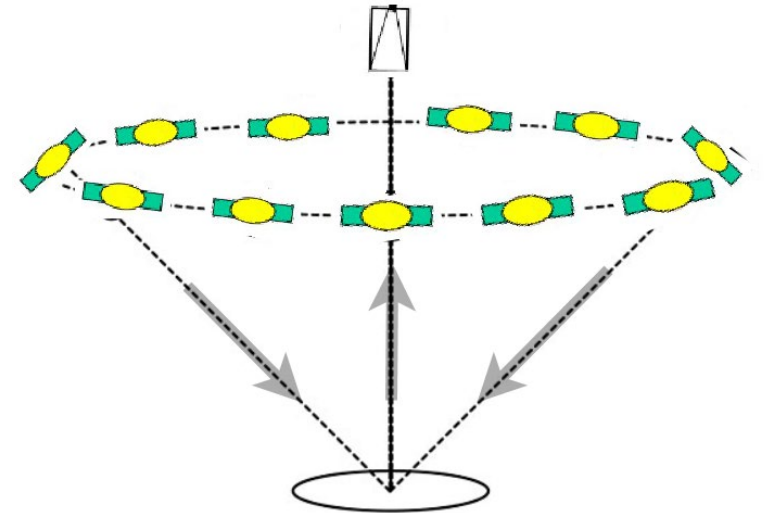

**45/0** – Illumination at 45 degrees and detection at 0 degrees

**0/45** – Illumination at 0 degrees and detection at 45 degrees

**45/0** – Circumferential  
Illumination at 45 degrees at multiple locations and detection at 0 degrees

# Specular Reflection

*Diffuse Reflection - Gloss*

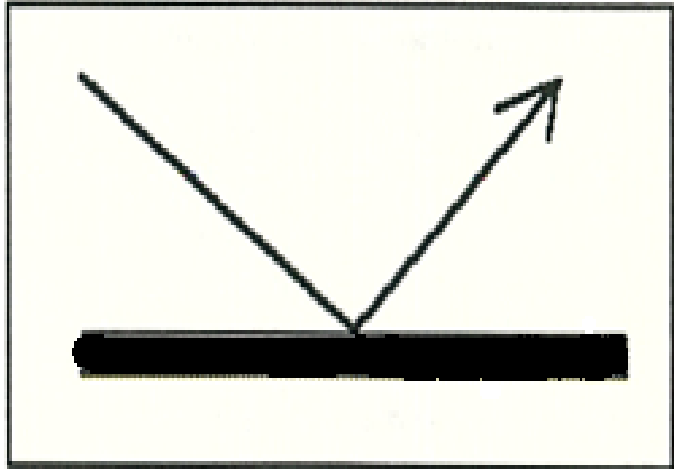

High Gloss Surface

A high gloss surface will reflect light back at only the specular angle.

A low gloss surface will reflect light back at many angles.

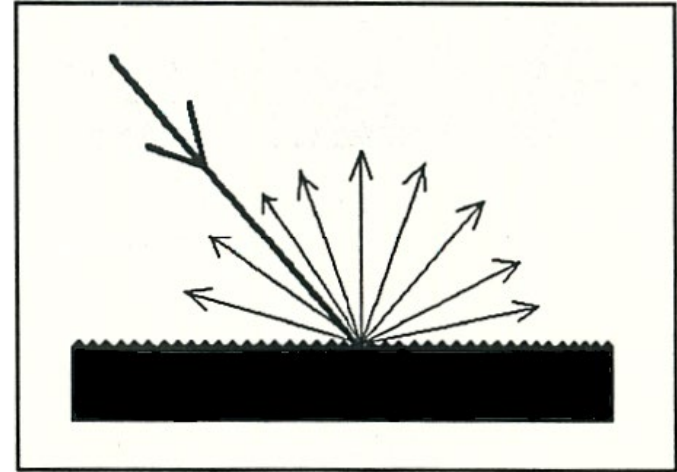

Low Gloss Surface

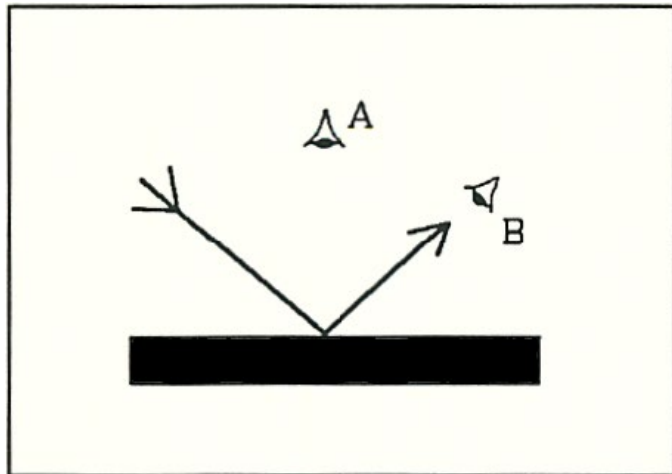

For the high gloss surface, the viewer at position A will not see the specular and will see a dark black.

For the low gloss surface, the viewer at A will see the specular and will see a lighter black.

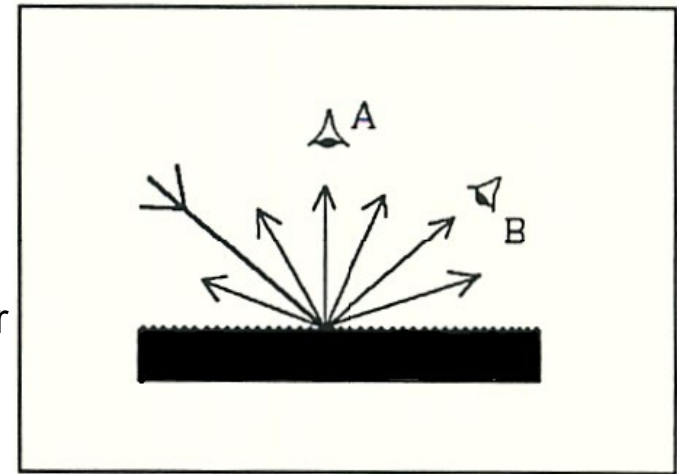

# Black Gloss Ladder

*Black Samples with Different Specular Gloss*

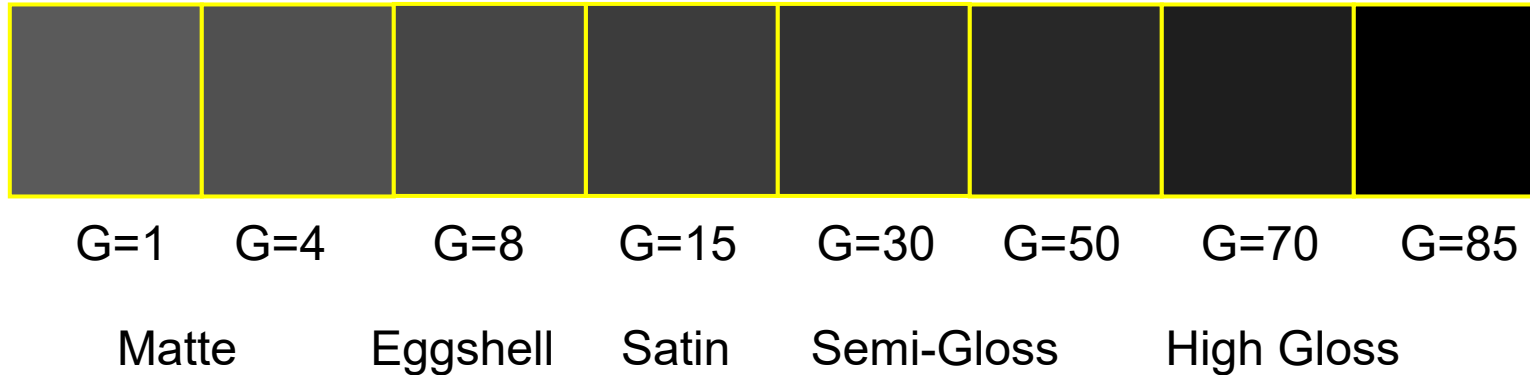

The samples contain the same black pigment but vary in specular gloss.

Most of the light in sample is absorbed and what we see is the specular %R reflected from the surface.

Visually the lowest gloss samples look lighter. As the gloss increases the samples look darker. The high gloss sample (G=85) is the darkest while the lowest gloss sample (G=1) is the lightest.

# Geometry Difference

*d8 SCI vs d8 SCE vs 45/0*

Y - Black Gloss Ladder

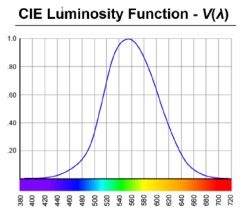
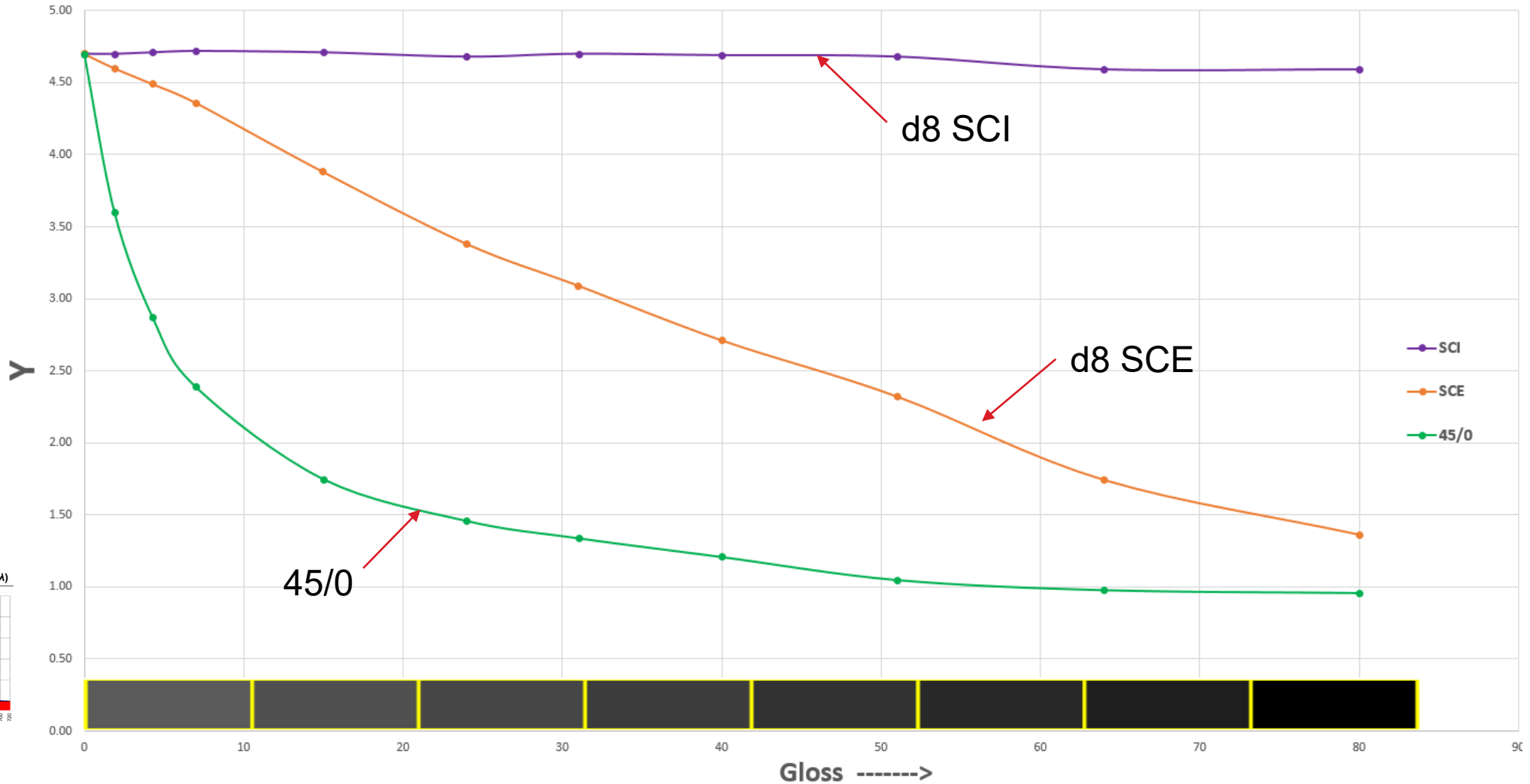

# Comparison d/8 SCI and 45/0

High Gloss Black Sample and Low Gloss Black Sample

## Black High Gloss vs Black Low Gloss – Measured with SCI (Specular Component Included Geometry)

DC QC 3 View Panel Screen Template

Current Illuminant	Std. Name	Std. CIE X	Std. CIE Y	Std. CIE Z	Std. CIE L	Std. CIE a	Std. CIE b	Std. CIE C	Std. CIE h	
D65 10 Deg	Black Gloss 85 S1_SCI	4.34	4.56	4.97	25.45	0.12	-0.35	0.37	288.52	
A 10 Deg		5.07	4.56	1.63	25.44	0.01	-0.33	0.33	271.61	
F11 10 Deg		4.75	4.57	3.04	25.46	0.06	-0.36	0.37	279.27	

Current Illuminant	Batch Name	Batch CIE X	Batch CIE Y	Batch CIE Z	CIE DL	CIE Da	CIE Db	CIE DC	CIE DH	CIE DE	CMC DE	CIE2000 DE
D65 10 Deg	Black Gloss 2 S13_SCI	4.33	4.56	4.94	-0.02	0.02	0.11	-0.09	0.07	0.12	0.18	0.12
A 10 Deg		5.07	4.56	1.62	-0.01	0.04	0.13	-0.12	0.06	0.13	0.20	0.14
F11 10 Deg		4.75	4.56	3.02	-0.01	0.02	0.14	-0.13	0.06	0.14	0.21	0.14

## Black High Gloss vs Black Low Gloss – Measured with 45/0 (45/0 Geometry)

DC QC 3 View Panel Screen Template

Current Illuminant	Std. Name	Std. CIE X	Std. CIE Y	Std. CIE Z	Std. CIE L	Std. CIE a	Std. CIE b	Std. CIE C	Std. CIE h	
D65 10 Deg	Black Gloss 85 S1_245	0.84	0.88	0.91	7.96	0.32	0.50	0.59	57.78	
A 10 Deg		1.00	0.89	0.30	8.03	0.45	0.59	0.74	53.13	
F11 10 Deg		0.93	0.89	0.56	7.99	0.29	0.58	0.65	63.53	

Current Illuminant	Batch Name	Batch CIE X	Batch CIE Y	Batch CIE Z	CIE DL	CIE Da	CIE Db	CIE DC	CIE DH	CIE DE	CMC DE	CIE2000 DE
D65 10 Deg	Black Gloss 2 S13_245	2.52	2.65	2.85	10.60	-0.17	-0.59	-0.42	-0.45	10.62	20.77	6.88
A 10 Deg		2.95	2.65	0.93	10.54	-0.33	-0.65	-0.62	-0.39	10.57	20.66	6.87
F11 10 Deg		2.75	2.64	1.74	10.56	-0.18	-0.69	-0.50	-0.50	10.58	20.69	6.87



- **0/45 and 45/0**
  - Usually less expensive
  - Always include surface in measurement
  - Sensitive to surface variations as well as to color
  - Specular excluded only
  - Better correlation with visual perception, popular for QC
- **Integrating Sphere**
  - Studies have shown best inter-instrument agreement across manufacturers and models
  - Diffuse illumination averages surface irregularities
  - Has been the preferred geometry for color formulation
  - More measuring options
    - Specular excluded - measures surface differences
    - Specular included - ignores surface differences
    - Transmission
    - Gloss compensation – improves correlation with visual assessment

# Colorimeter

*No Spectral Curve*

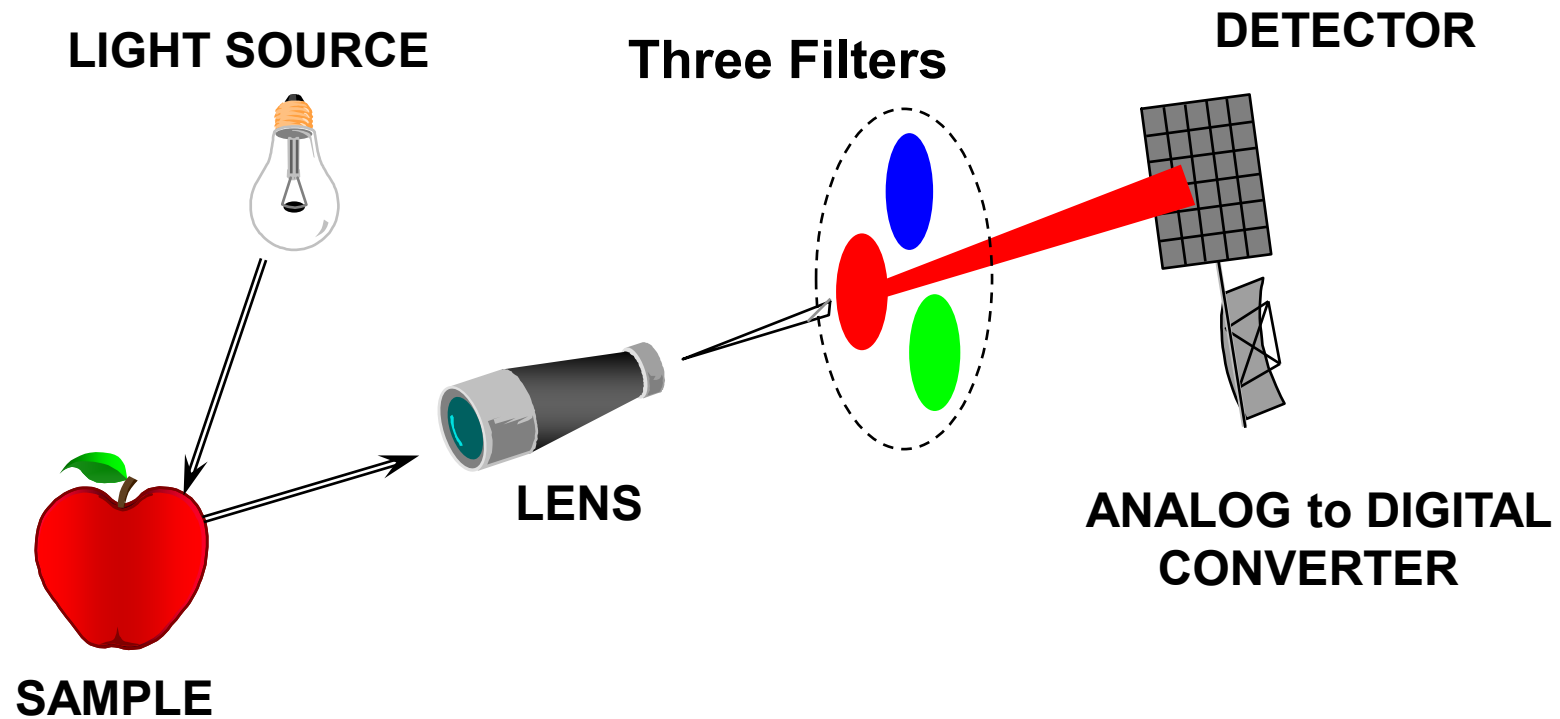

# Gonio-spectrophotometer

*Multi-Angle Measurement of Metallics and Effect Pigments*

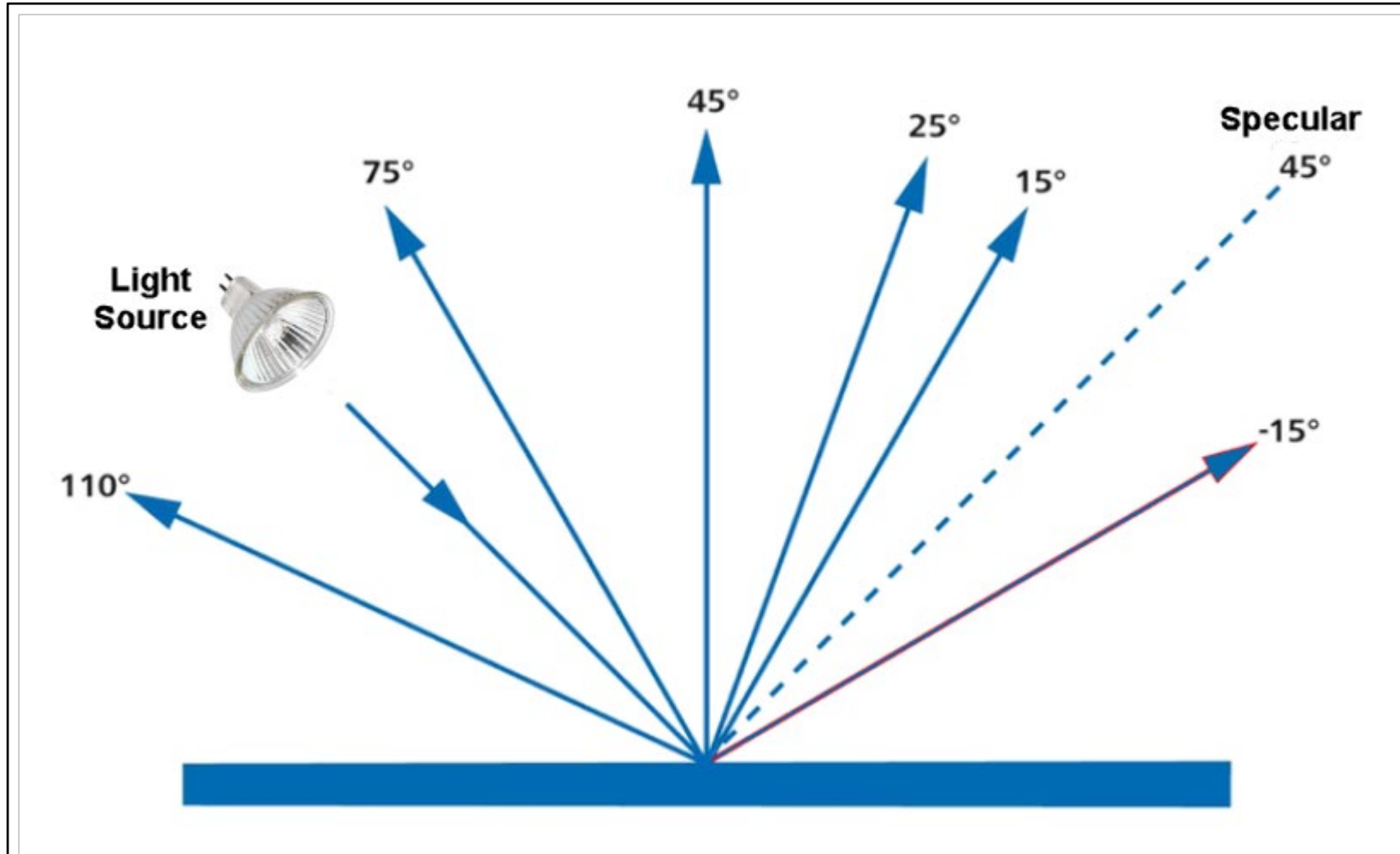

# Reflectance

*Transparent, Translucent and Opaque*

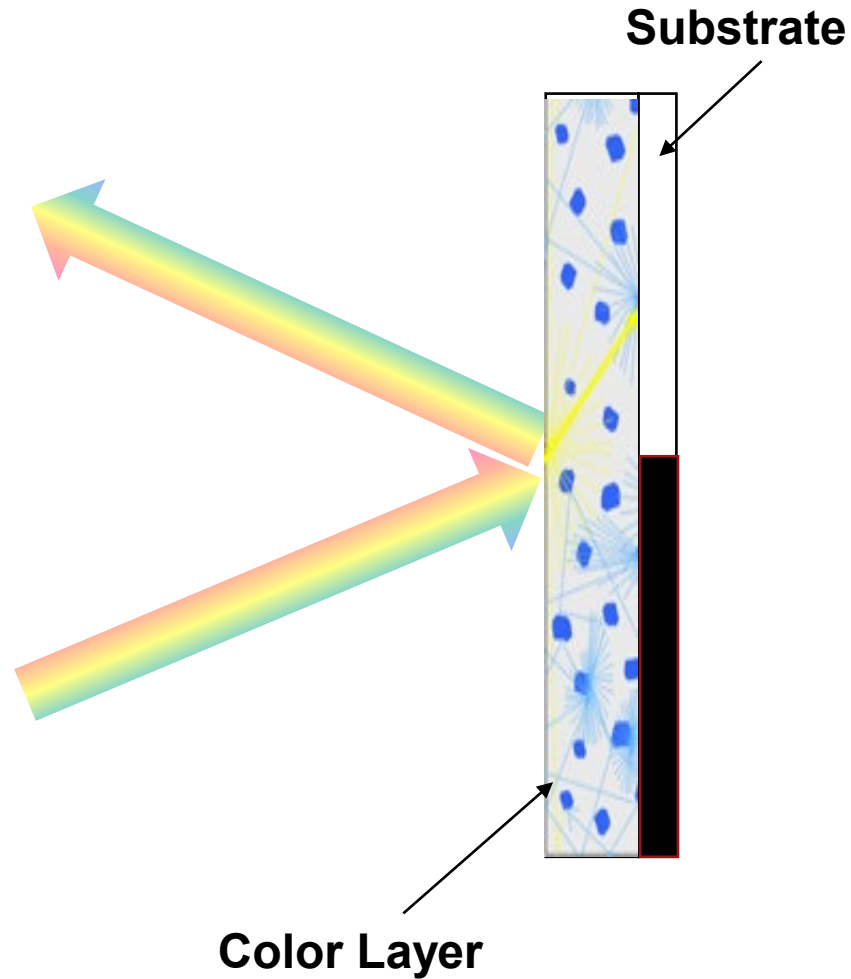

**Transparent** – Light can be absorbed but generally is transmitted without scattering. Substrate visible.

**Translucent** – Light can be absorbed and scattered but can penetrate the material. Substrate visible.

**Opaque** – Light can be absorbed and scattered but cannot penetrate the material. Substrate not visible.

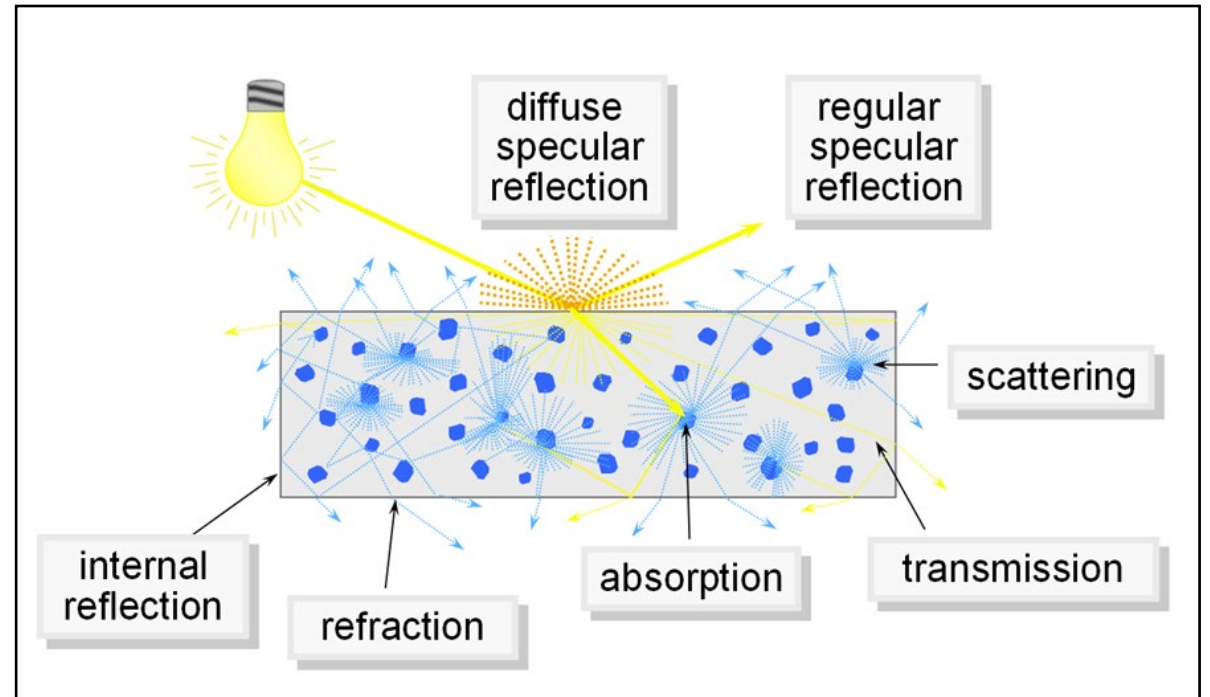

# Opacity Measurement

Contrast Ratio and Contrast DE

$$\text{Contrast Ratio (CR)} = Y_{\text{black}} / Y_{\text{white}} * 100$$

Contrast Ratio (CR) > 98.0 Considered Opaque?

$$\text{Contrast Ratio (CR)} = 17.61_{\text{black}} / 39.20_{\text{white}} * 100 = \mathbf{44.92}$$

**CDE\* = 35.05**

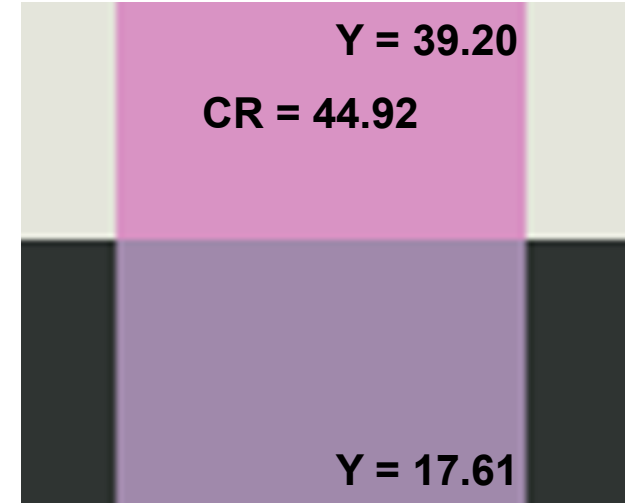

$$\text{Contrast DE}^* = \text{Sample}(L^*a^*b^*)_{\text{black}} \text{ to } \text{Sample}(L^*a^*b^*)_{\text{white}}$$

Contrast DE\* < .25 Considered Opaque?



# Transmission

*Transparent and Translucent*

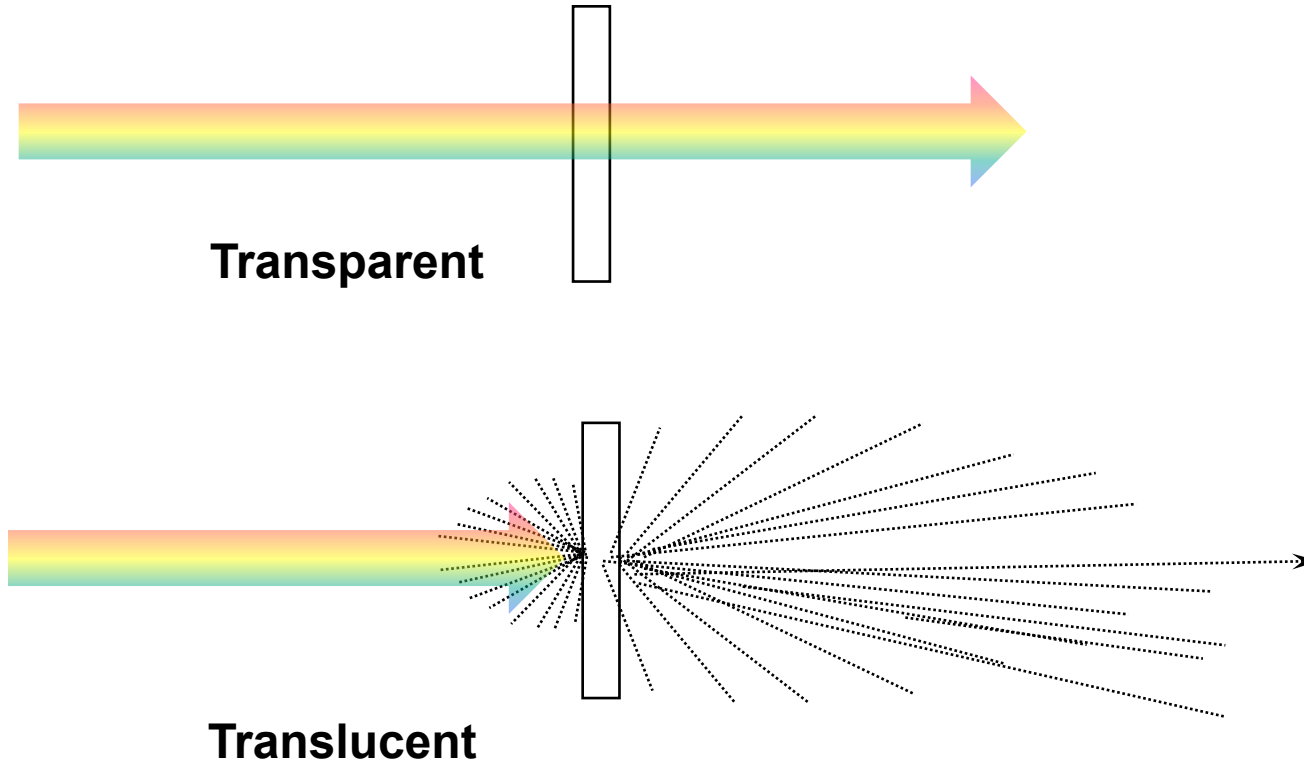



# Best Practices for Instrumental

---

- Training, Training, Training
- Test, Document and Maximize Repeatability
- Test, Document and Maximize Reproducibility – Determine Process Capability
- Standardize and Document Internal and Customer Procedures (SOP)
  - Illuminant and Observer
  - Area of View – LAV, SAV, etc.
  - Specular Component
  - UV Status
  - Averaging Techniques
  - Sample Thickness or Opacity Issues
  - Conditioning - Humidity and Temperature
- Daily Calibration
- Regular Diagnostics
- Annual Service
- Understand and Minimize the Other Variables

# Gloss Measurement

*Gloss Meter – 20, 60, 85*

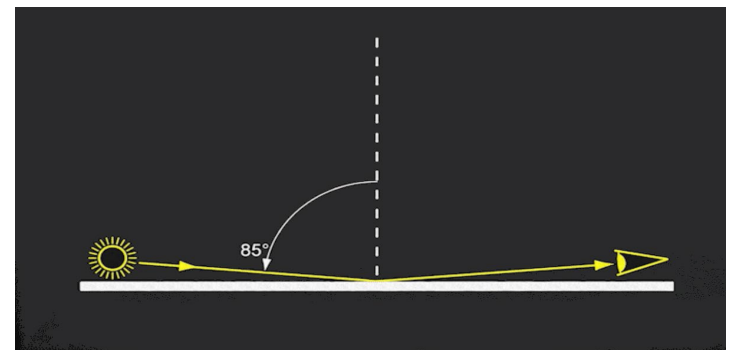
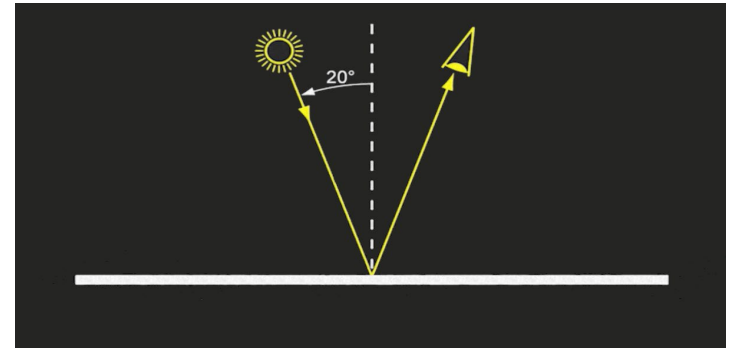
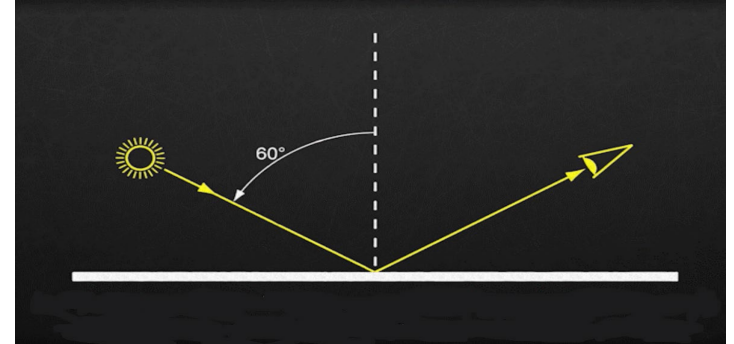
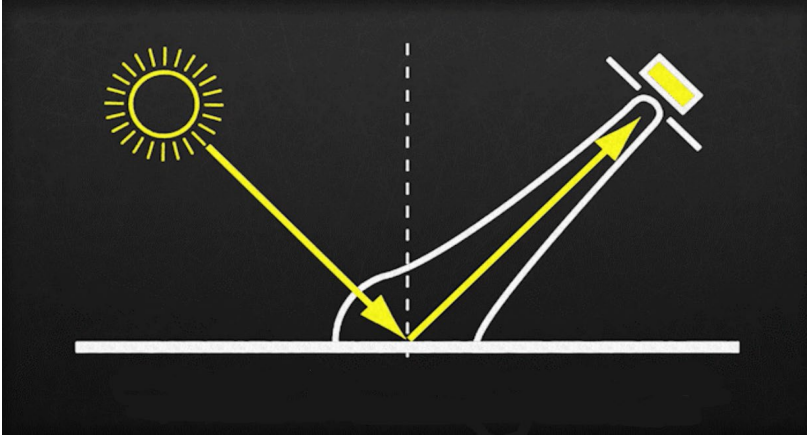

## Universal Measurement Angle: 60°

All gloss levels can be measured using the standard measurement angle of 60°. This is used as the reference angle with the complimentary angles of 85° and 20° often used for low and high gloss levels, respectively.

## Low Gloss: 85°

For improved resolution of low gloss a grazing angle of 85° is used to measure the surface. This angle is recommended for surfaces which measure less than 10GU when measured at 60°.

## High Gloss: 20°

The acute measurement angle of 20° gives improved resolution for high gloss surfaces. Surfaces that measure 70GU and above at the standard angle of 60° are often measured with this geometry.

# Simultaneous Contrast

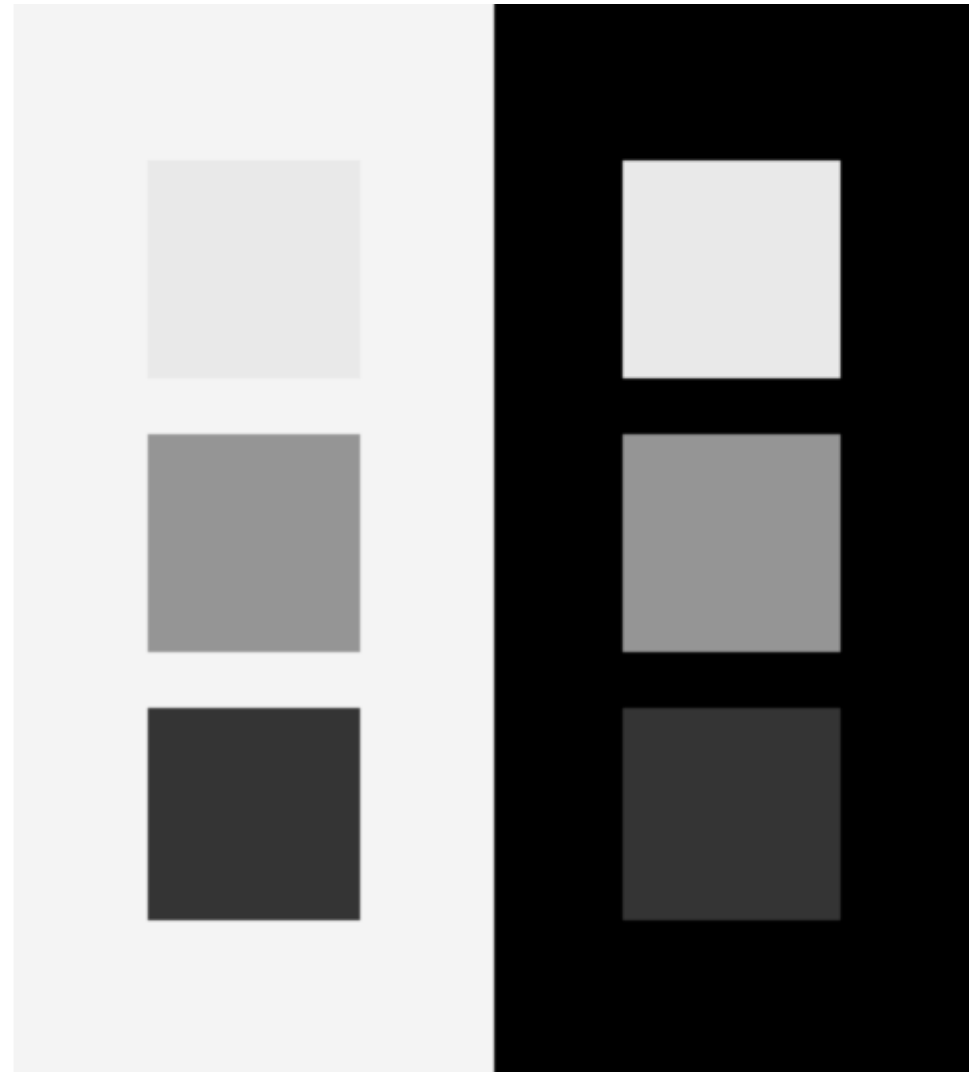
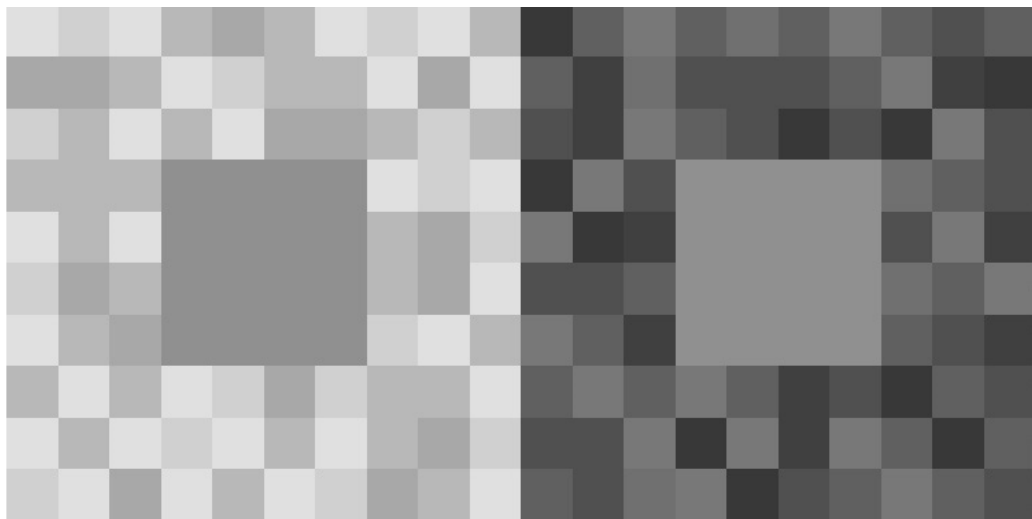
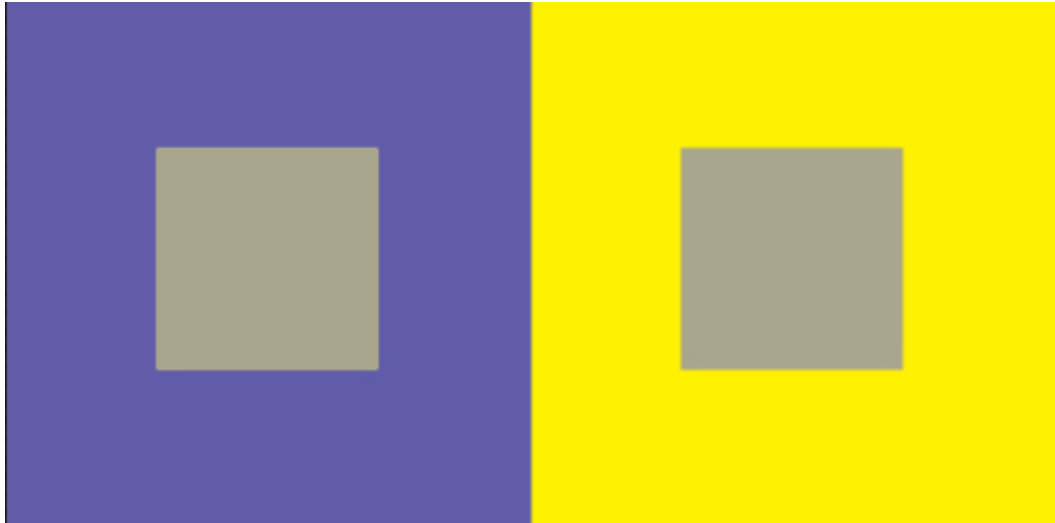

# Successive Contrast

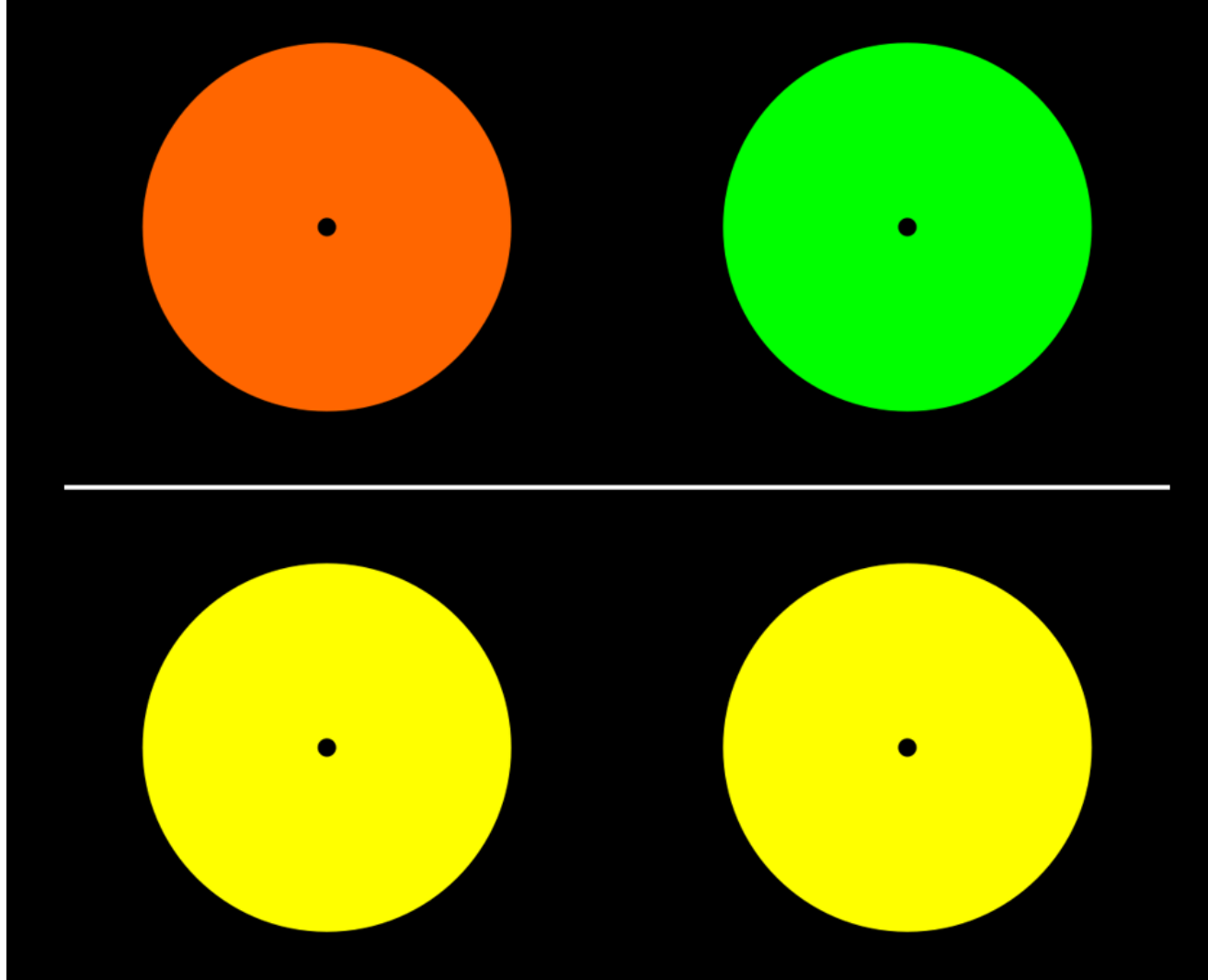

# Checker Shadow Illusion

By Edward Adelson, MIT *Simultaneous Lightness Contrast*

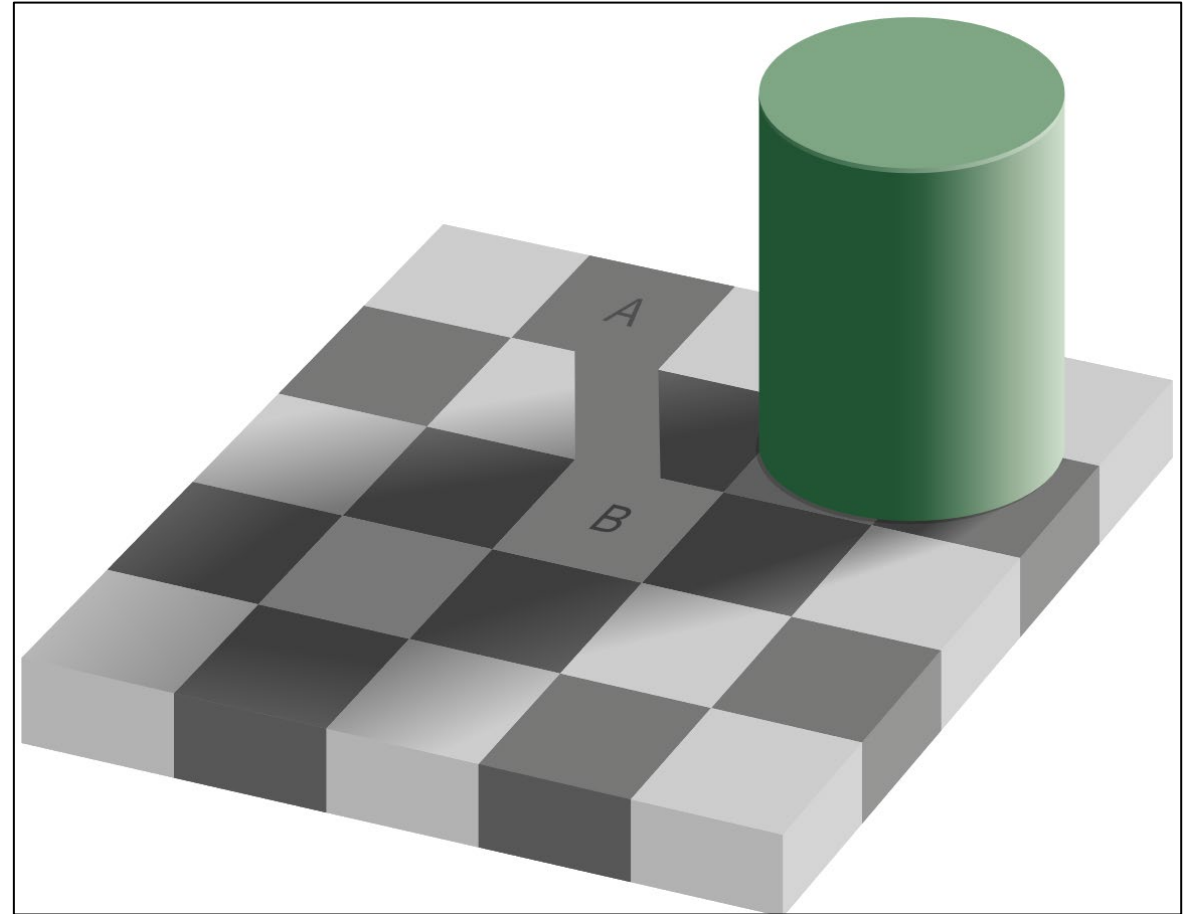
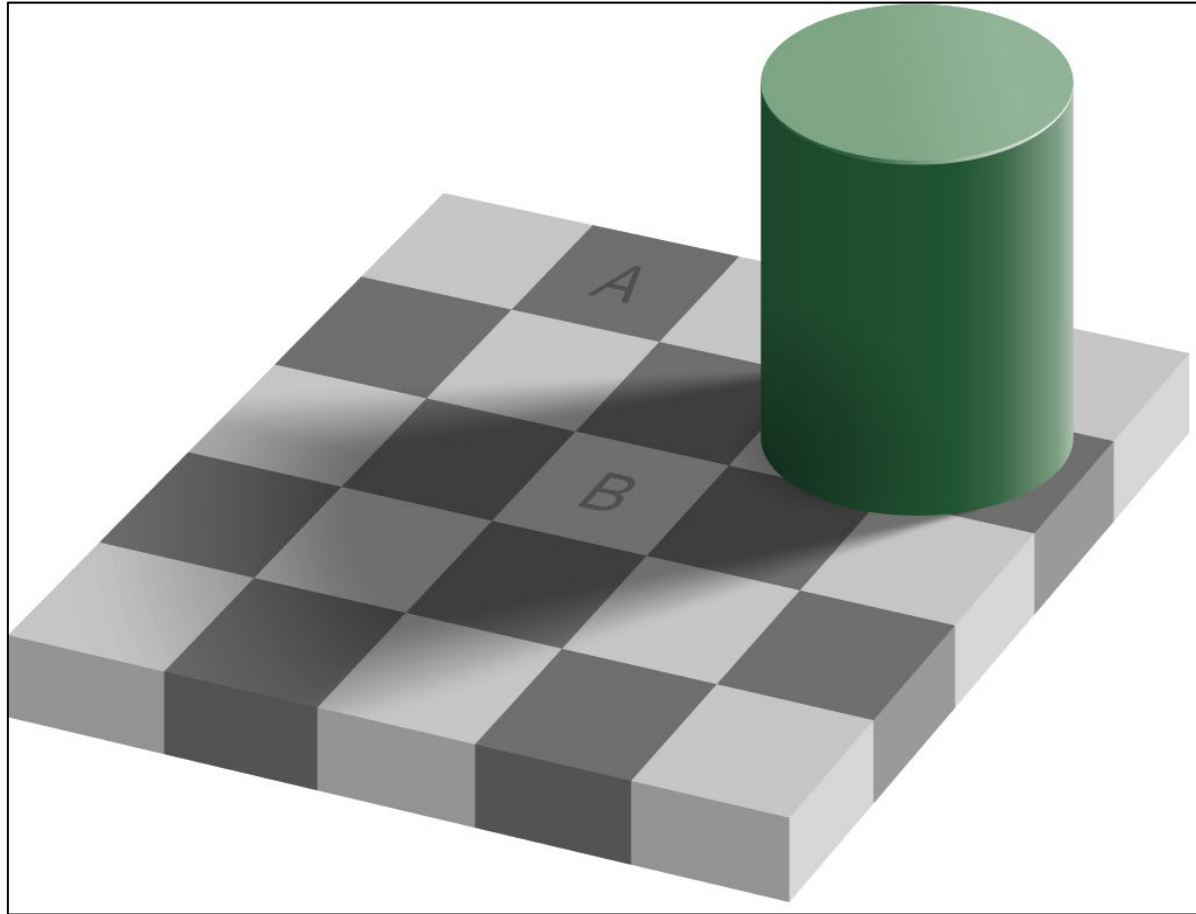

# Color Constancy

The tendency of objects to appear the same color under changing illumination.

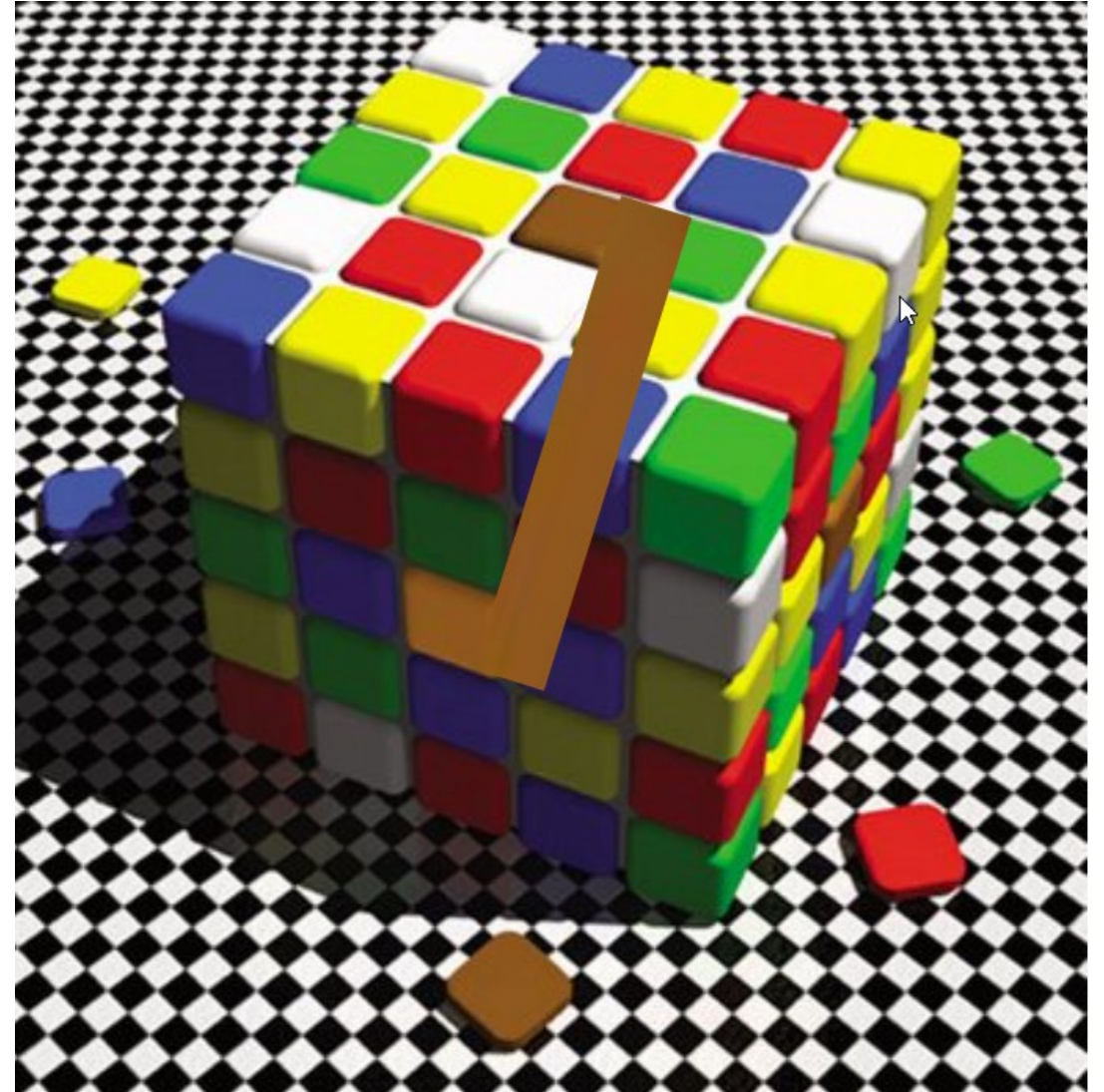



# Color Constancy – Color Contrast

Yellow Light

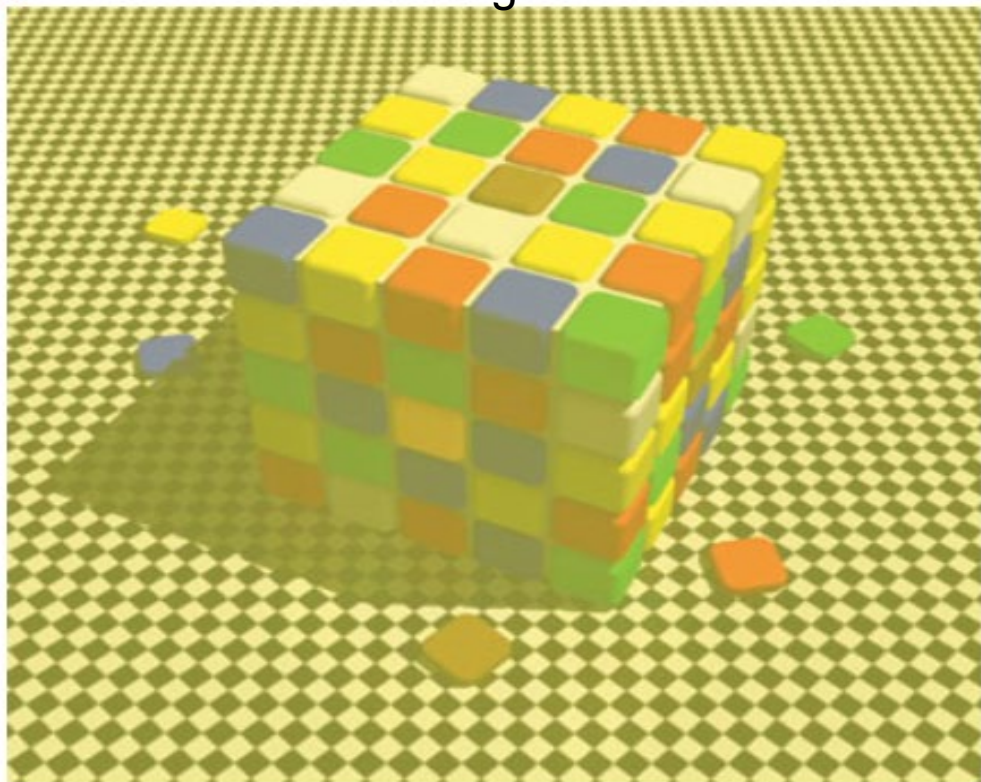

Blue Light

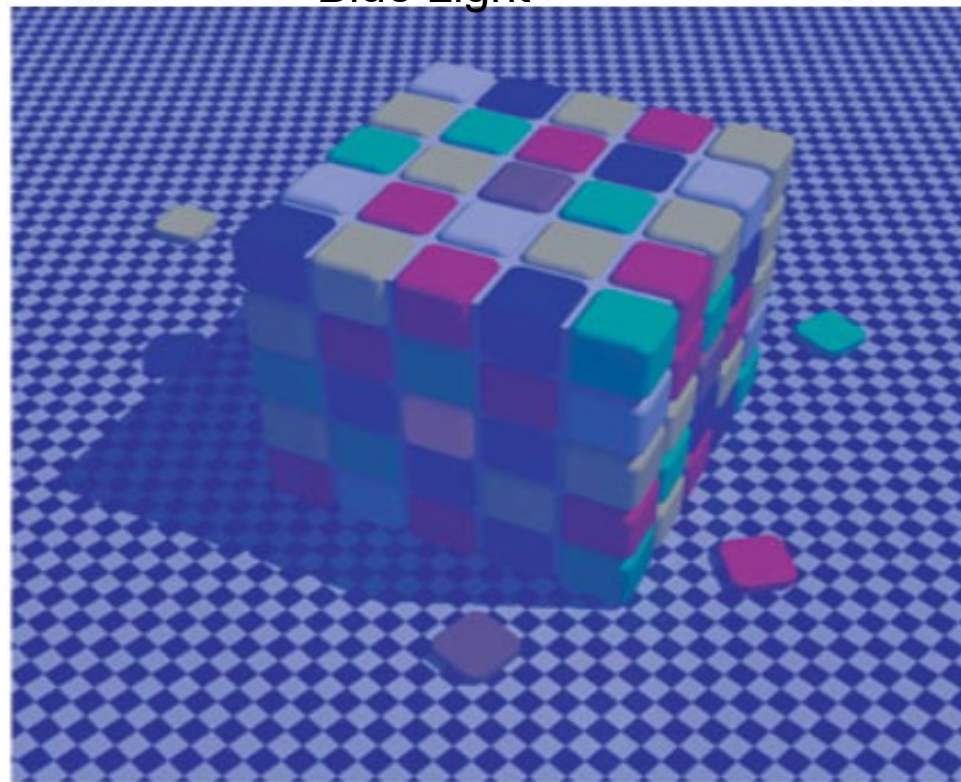

blue

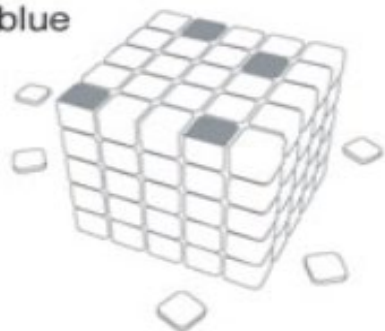

red

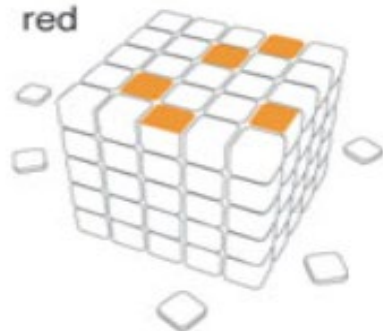

yellow



red

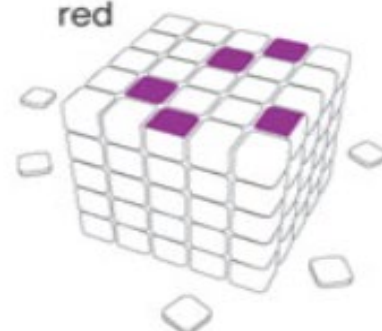



# Color Constancy – Color Contrast

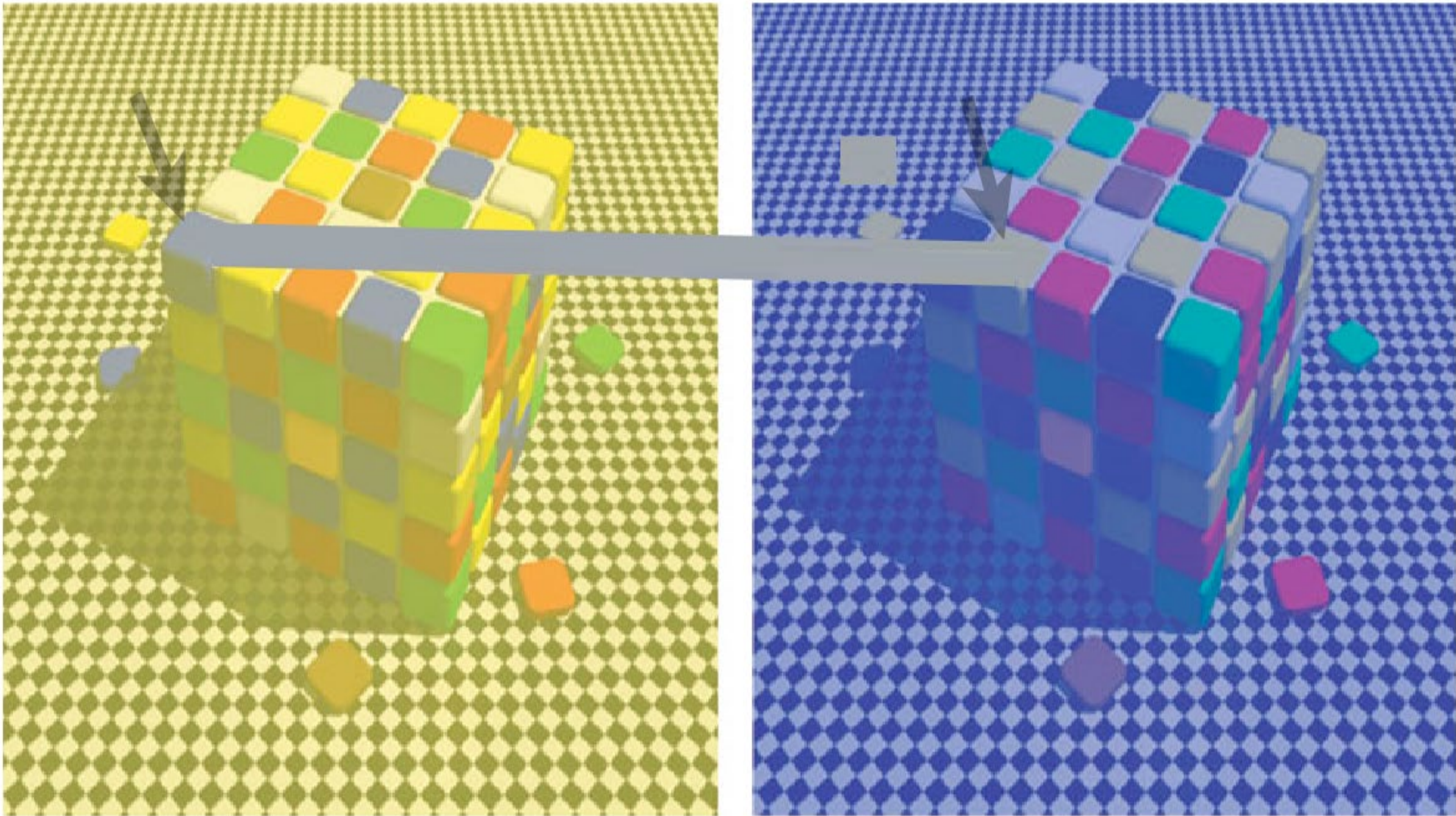

# Color Constancy

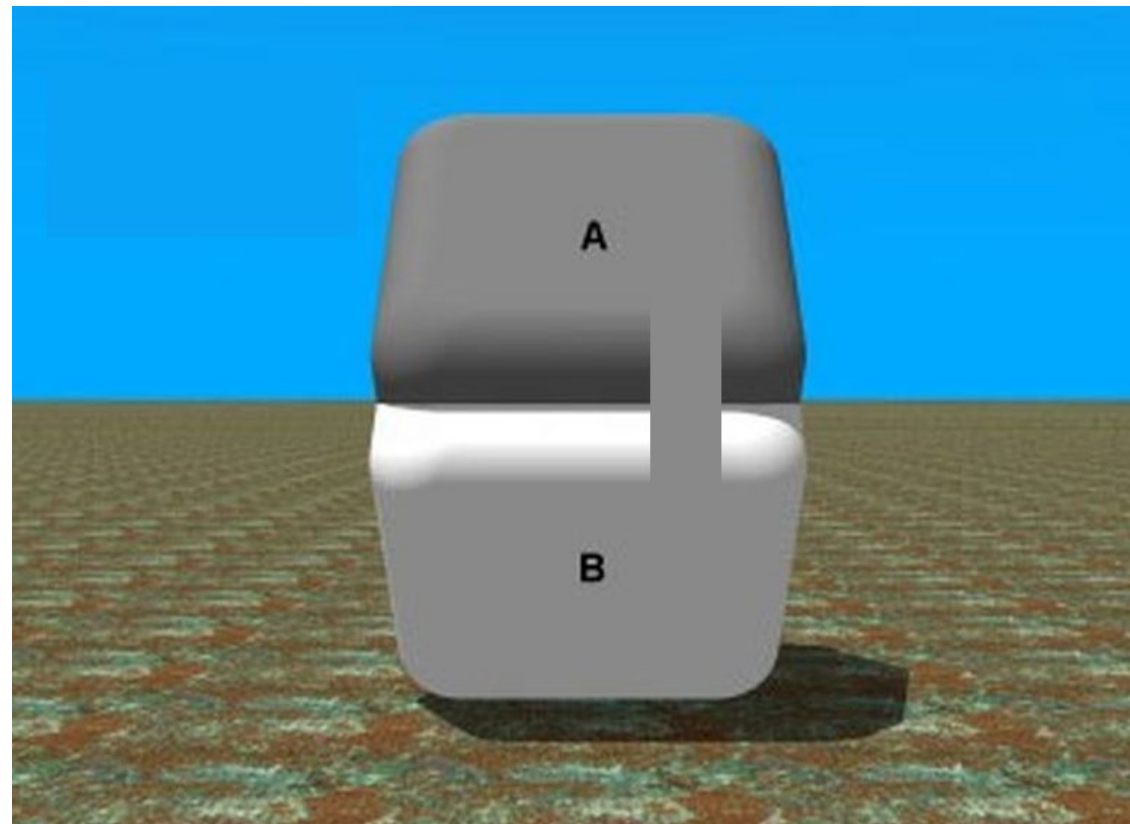
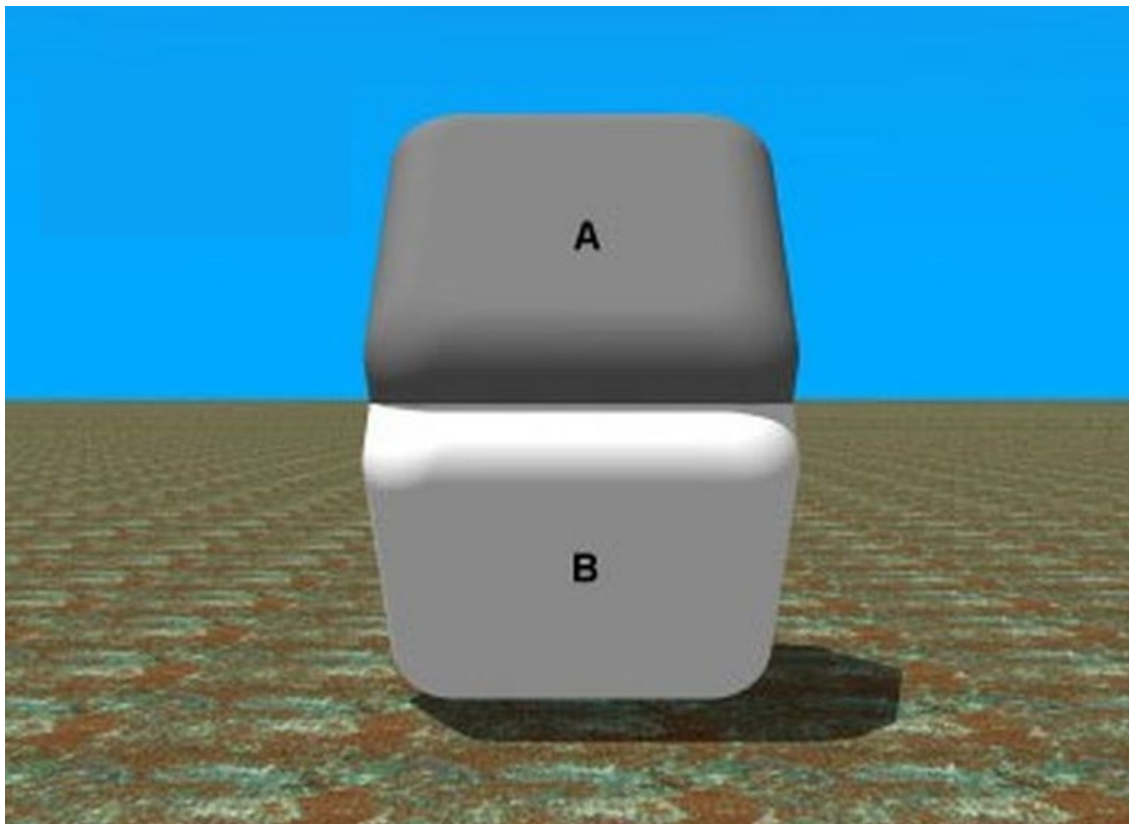

# Visual Adaptation

*Light, Dark, Chromatic Adaptation*

**Light Adaptation** is the decrease in visual sensitivity with increases in the level of illumination. An example would be waking up at night in a dark room and turning on a bright light. For a little while you will not be able to see very well but after some time you will begin to have normal vision. Another example is how we can see stars very clearly at night but cannot see them during the day. The luminance during daylight is much greater than at night.

**Dark Adaptation** is similar but opposite. An example is entering a dark room from a bright setting. If you go into a dark movie theatre from a bright sunlight, you cannot see anything. After a while you begin to see better and after 5 minutes or so, you begin to see much better.

**Chromatic adaptation** is the human visual system's ability to adjust to changes in illumination in order to preserve the appearance of object colors. It is responsible for the stable appearance of object colors despite the wide variation of light which might be reflected from an object and observed by our eyes.

An example of Chromatic Adaptation would be moving between rooms with different types of illumination. A white object will still look white in the different room. If you changed the lighting quickly, you would see a color change momentarily but then you would adapt and see white.



# Chromatic Adaptation

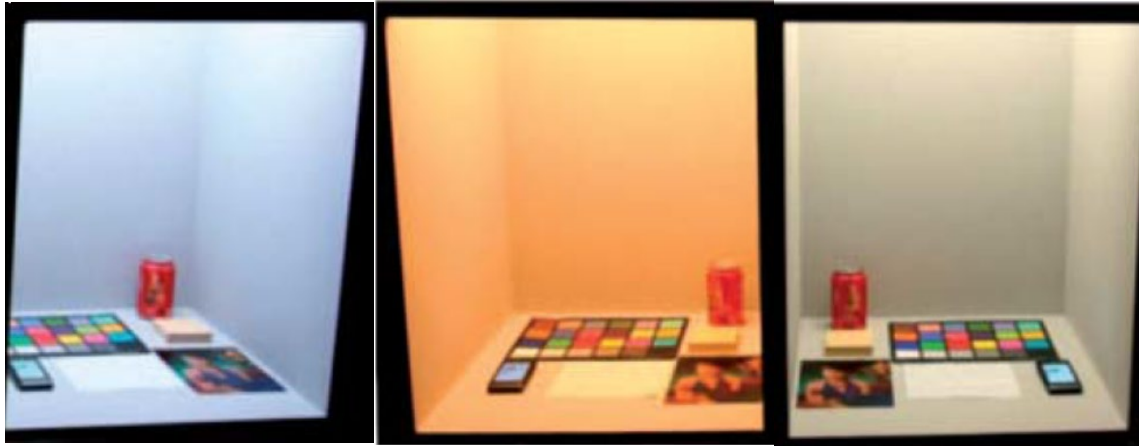

These light booths viewed from afar look different. However, if you view a single booth and move from one to another, you will adapt.

The examples shown at the right are screen displays of color patches with and without a chromatic adaptation correction applied.



## Without Chromatic Adaptation Correction

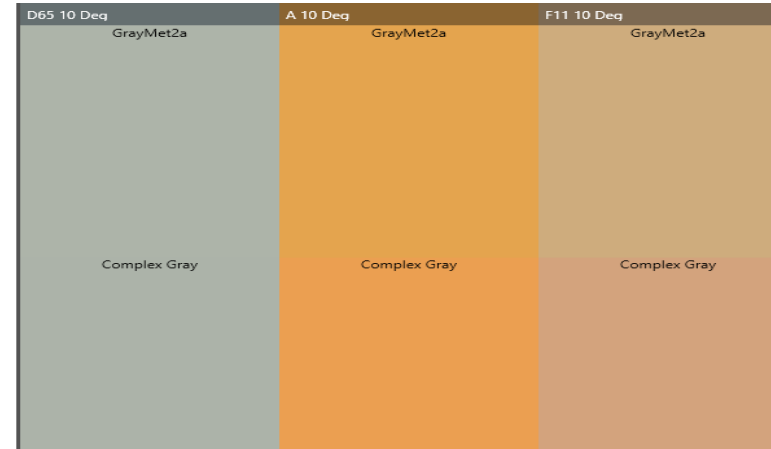

## With Chromatic Adaptation Correction

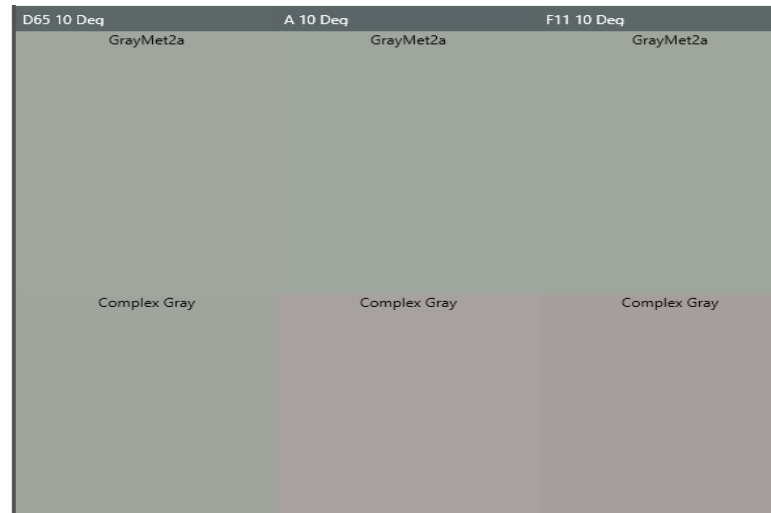

# Questions from Last Week

---

Tolerance = 1, batches are on opposite sides of acceptability sphere.

Illuminant C vs D65

Tolerance without batch data yet

Gloss differences affecting reading DE2000

Gloss difference confused with metamerism

Gloss management, need gloss meter?

CMC and DE2000 tolerances together

CMC in textile industry

AI P/F red fail batches in pass area

## Want to learn more?

---

Sign up at [Datacolor Academy](#) for classroom style lectures and demonstrations covering useful color topics in select venues around the globe

Follow [Datacolor Blog](#) for more useful information

# Thank you and follow us:



[www.facebook.com/DatacolorCorporate](https://www.facebook.com/DatacolorCorporate)



[www.linkedin.com/company/datacolor](https://www.linkedin.com/company/datacolor)



[www.youtube.com/user/DatacolorIndustrial](https://www.youtube.com/user/DatacolorIndustrial)