

# BOOK FOUR OF COLOR MANAGEMENT

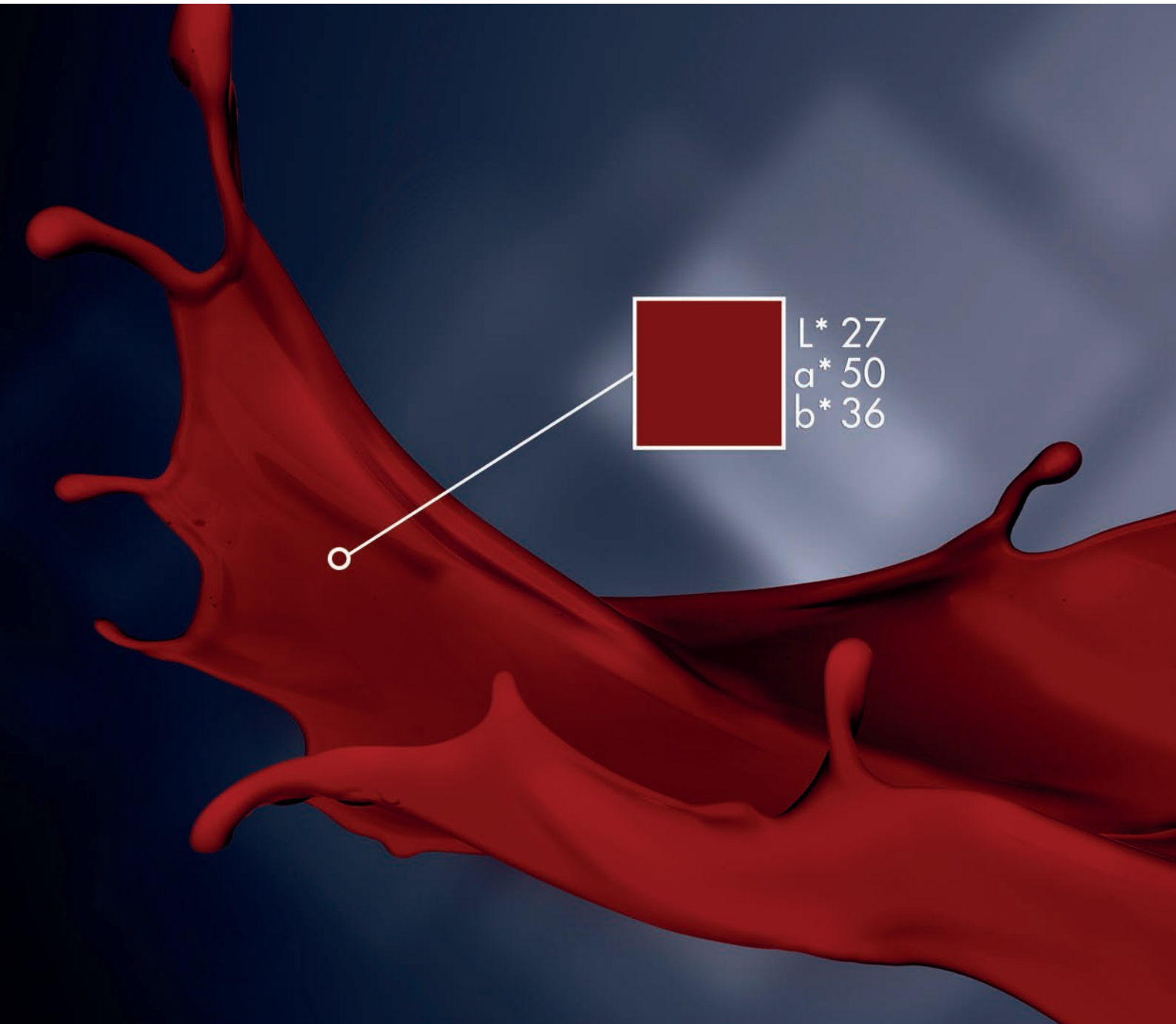

## Color distances, metamerism and practical color equations

# Color distances and acceptability of colors

## Introduction

Most industries require that their products demonstrate color consistency from one batch to another. For example, if you are painting a room and you run out of paint, you expect that there will be no visible difference between the two batches used. There are also products for which color consistency is required across a variety of materials. Your automobile contains parts of the same color, such as plastic arm rests, carpeting, cloth interiors, etc. that are made from different materials and processes. Often these components may display small color differences when located side-by-side, but if the differences are small you find them visually acceptable. In either case, when the color is grossly inconsistent, you will probably reject the product as defective.

In practice, it is generally impossible to reproduce the color of a product 100% exactly; as in the example below, the t-shirt could exhibit minimal color differences in different places, even if we cannot perceive any differences visually. Using colorimetry, such color differences can be measured and recorded. Color measurement and the evaluation of color differences help the manufacturer greatly in adhering to the specifications agreed between customer and supplier. In order to determine the difference between the colors of two samples, the color coordinates of the standard and of the reconstruction are entered in a color space; the distance of these two color points from each other shows the color difference between the samples. The distance between two points is calculated with a relationship based on its spatial projection onto each of the three main variables of the color system. This is the main application of the CIELAB color system and the color differences determined in this system.

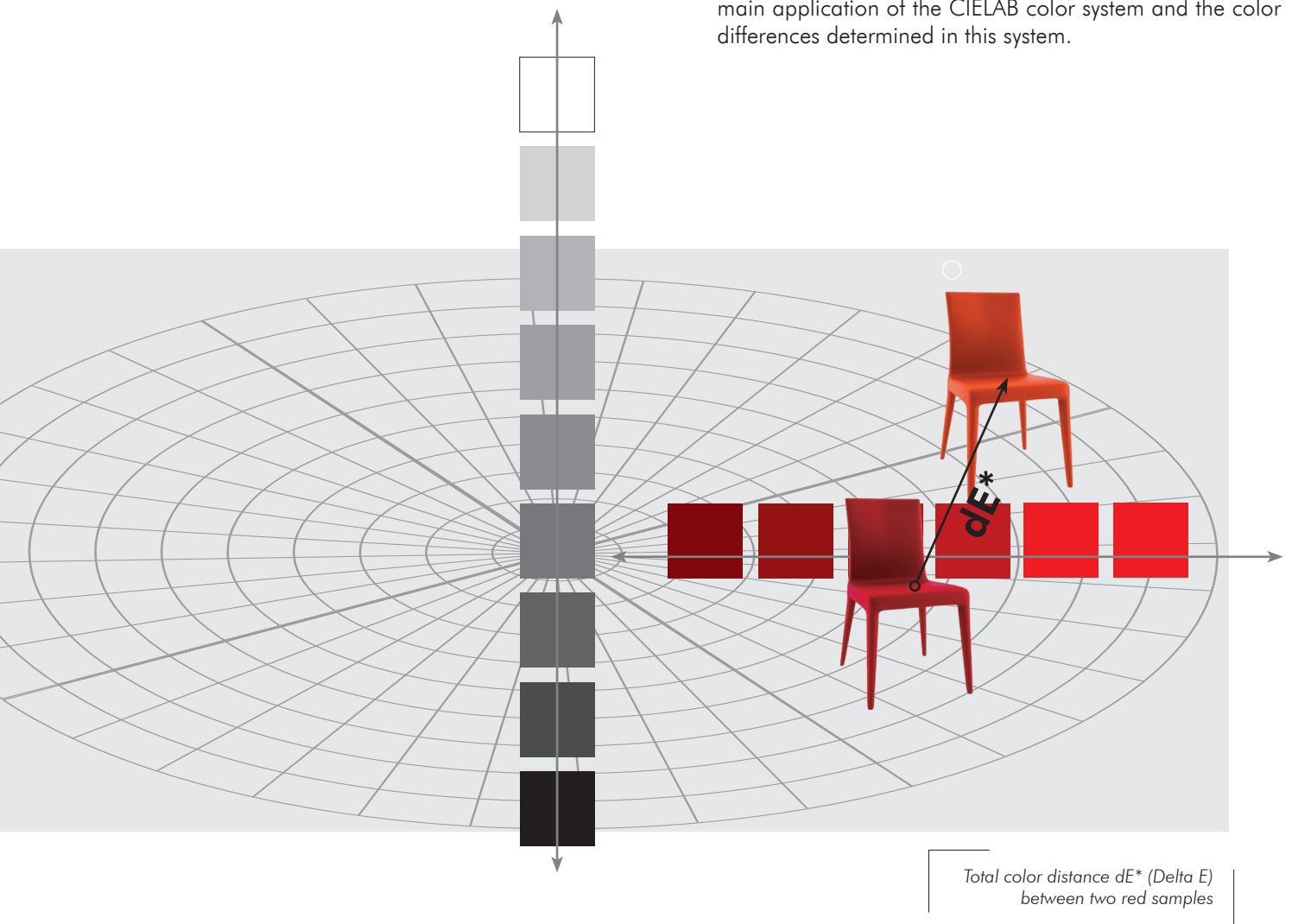

## Color differences in the CIELAB color space

The color distance between two colors is specified as  $dE$  (alternative notation: Delta E,  $\Delta E$ ). It can be calculated by a formula that was developed in 1976. Thus, the CIELAB color space allows the color deviations to be represented using two procedures as follows:

- With perpendicularly plotted coordinates  $L^*$ ,  $a^*$  and  $b^*$ , the formula is as follows:

$$dE^* = \sqrt{dL^{*2} + da^{*2} + db^{*2}}$$

where

- $dL^*$  represents the deviation of the lightness on the  $L^*$  axis
- $da^*$  represents the red-green deviation on the  $a^*$  axis
- $db^*$  represents the yellow-blue deviation on the  $b^*$  axis

- With cylindrically plotted coordinates  $L^*$ ,  $C^*$  and  $h$ , the formula is as follows:

$$dE^* = \sqrt{dL^{*2} + dC^{*2} + dH^{*2}}$$

where

- $dL^*$  represents the deviation of the lightness on the  $L^*$  axis
- $dC^*$  represents the deviation of the colorfulness or chroma on the radius  $C^*$
- $dH$  (in degrees) represents the deviation of the hue angle on  $h$

Standard ( $S_0$ )                      Sample ( $E_1$ )

$L^*_0 = 52.15$	$dL^* = +3.40$	$L^*_1 = 55.55$
$a^*_0 = +51.72$	$da^* = +2.60$	$a^*_1 = +54.32$
$b^*_0 = +19.29$	$db^* = +1.80$	$b^*_1 = +21.09$

$$dE^* = \sqrt{dL^{*2} + da^{*2} + db^{*2}}$$

$$dE^* = \sqrt{3.40^2 + 2.60^2 + 1.80^2} = 4.64$$

By D65 / 10°

CIELAB color space. Color distances in  $L^* a^* b^*$

Standard ( $S_0$ )                      Sample ( $E_1$ )

$L^*_0 = 52.15$	$dL^* = +3.40$	$L^*_1 = 55.55$
$C^*_0 = 55.20$	$dC^* = +3.06$	$C^*_1 = 58.26$
$h_0 = 20.45^\circ$	$\left. \begin{matrix} dh = 0.77^\circ \\ dH^* = 0.78 \end{matrix} \right\}$	$h_1 = 21.22^\circ$

$$dE^* = \sqrt{dL^{*2} + dC^{*2} + dH^{*2}}$$

$$dE^* = \sqrt{3.40^2 + 3.06^2 + 0.78^2} = 4.64$$

By D65 / 10°

CIELAB color space. Color distances in  $L^* a^* b^*$

Since the equation for the distance calculation (for the parameter  $dh$ ) can be expressed only in units of length, the distance of the hue angle  $dh$  (actually expressed in  $^\circ$ ) is converted into a unit of length. This hue distance is specified with  $dH^*$ , in conjunction with the radius of the color circle  $C^*$ , which represents the chroma.

## Color deviations and color tolerances in the CIELAB color space $L^* a^* b^*$

The description of a color deviation via perpendicularly plotted coordinates  $L^*$ ,  $a^*$  and  $b^*$ , in terms of the physics of perception, follows opponent color theory:

- Red/green deviation: projection of the distance onto the  $a^*$  axis
- Yellow/blue deviation: projection of the distance onto the  $b^*$  axis

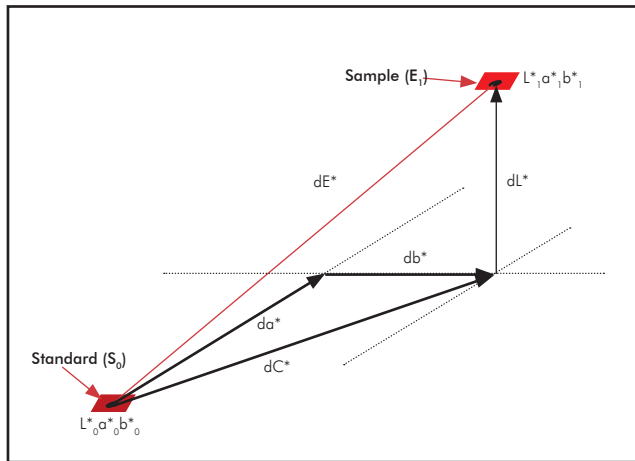

Color deviations  $dL^*$   $da^*$   $db^*$  expressed in perpendicular coordinates

Tolerances  $dL^*$   $da^*$   $db^*$  expressed in perpendicular coordinates in the CIELAB color space

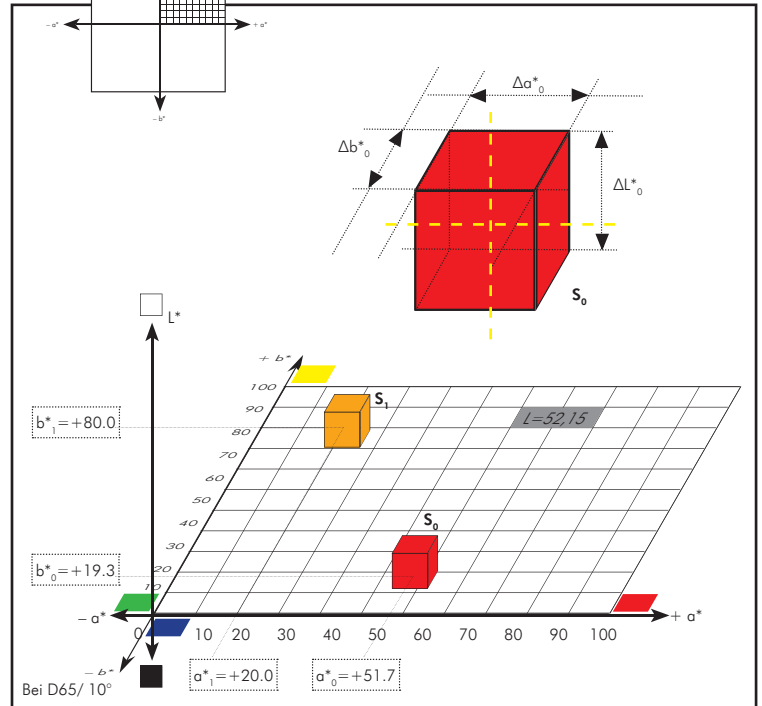

$dE^*$  total color distance

$dL^*$  difference in lightness (⊖ = darker; ⊕ = lighter)

$da^*$  green color difference ⇔ red (⊖ = greener; ⊕ = redder)

$db^*$  yellow color difference ⇔ blue (⊖ = bluer; ⊕ = yellower)

## Color deviations and color tolerances in the CIELAB color space $L^* C^* h$

In contrast to the theoretical  $L^*a^*b^*$  system, colors in the actual perception space do not behave linearly with each other. The human eye does not perceive color distances (green, red, yellow, blue) to the same extent as differences in colorfulness (chroma) and lightness. Generally, a person will first perceive distances in color shade, then in colorfulness, and finally in lightness. A color distance of e.g.  $dE = 1$  is an acceptable color difference for brilliant yellow or green shades, but for achromatic grey colors, in contrast,  $dE = 1$  represents a different color that is not acceptable.

The same mathematical difference of 1, therefore, does not correspond with our visual impression. The CIELAB color space  $L^* C^* h$  provides an alternative in the "achromatic" area. Determination of the color deviation via cylindrically plotted coordinates  $L^*$ ,  $C^*$  and  $h$  in the CIELAB color space allows the description of color and color distances just as we see them. The total color difference ( $dE^*$ ) is split into the lightness difference ( $dL^*$ ), the chroma difference ( $dC^*$ ) and the hue difference ( $dH^*$ ).

Tolerances  $dL^*$   $dC^*$   $h$  expressed in cylindrical coordinates in the CIELAB color space

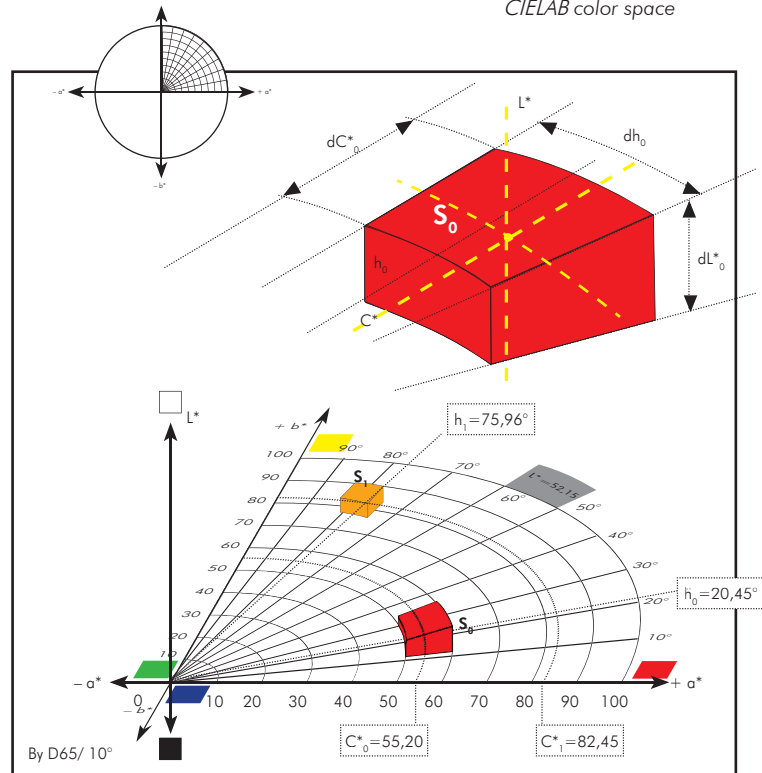

Color deviations  $dL^*$   $dC^*$   $dh^*$  expressed in cylindrical coordinates

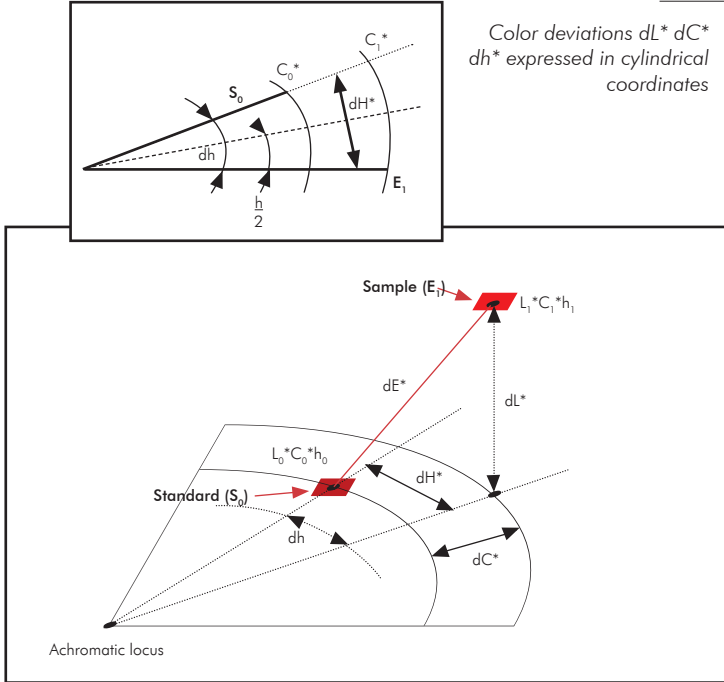

The formula is then as follows:

$$dE^* = \sqrt{(dL^*)^2 + (dC^*)^2 + (dH^*)^2}$$

$dh$  = hue angle difference: represents the difference in angle (in degrees) between the vector courses associated with the two colors (standard and sample). The angle difference  $dh$  is converted into a distance of length  $dh^*$  using the following transformation:

$$dH^* = 2 \sqrt{C^*_0 C^*_1} \cdot \sin\left(\frac{dh}{2}\right)$$

### L\* Lightness axis

$dL^*$  = Lightness difference: value and interpretation are identical with the description in the  $L^*a^*b^*$  system

### C\* Chroma (colorfulness)

$dC^*$  = Difference in colorfulness: represents the difference in the distances from each color point to the lightness axis.

### H° color shade (angle)

$dC^* = C^*_1 - C^*_0$   
 where  $C^*_0$  = chroma of the standard  
 and  $C^*_1$  = chroma of the sample

- if  $dC^*$  is positive, the sample has a higher chromaticity than the standard
- if  $dC^*$  is negative, the sample has a lower chromaticity than the standard

Breaking down the total color difference  $dE^*$  into  $dL^*$ ,  $dC^*$  and  $dH^*$  like this puts it on a level with describing color deviations using visual evaluation in natural classification. As it is simpler and more practical, this is the most frequently applied method.

**Color specialists very often use  $dL^*$ ,  $da^*$  and  $db^*$  as the form to express the color deviations, if  $C^* \leq 5$  and the color distance is evaluated according to  $L^*C^*H^*$   $> 5$ . If  $C^* \leq 5$ , then the coordinates  $L^*a^*b^*$  must be used for evaluation. If the value  $C^* > 5$ , then the coordinates  $L^*C^*H^*$  must be used for the evaluation.**

## CMC compliance system

The color distance formulae in the CIELAB color spaces  $L^*a^*b^*$  and  $L^*C^*h$  have the advantage of being relatively simple and practical in their application.

A disadvantage is that the CIELAB color system is not visually of uniform scale. The calculated color distances do not correspond to the perceived or sensed color distances for all colors. In practise, this means that for the achromatic colors, the human eye can distinguish the slightest differences in color shade. Accordingly, the lowest possible  $dE^*_{ob}$  numerical value had to be determined here. The more brilliant the color shades being evaluated, that is, the higher the C values, the further out are the colors in the CIELAB system, and the lower the sensitivity with which the human eye reacts to the color distances. Here, among others, a numerically higher  $dE^*_{ob}$  difference is not recognised by the eye. The eye is also better at evaluating differences in the color shade than differences in lightness or chroma (brilliance).

In order to avoid having to determine color tolerances per color in the CIELAB system, and to bring it more into line with the human eye, the  $dE^*_{ob}$  color distance formula was further improved. This brought about the CMC formula, for example, which is widespread today in the textile industry.

The CMC formula comes from Great Britain, where continuous research has been carried out since 1970. It was tested based on tens of thousands of visual evaluations and finally standardised by the UK standards body, the British Standards Institution. The original name, JPC70, was later changed to CMC (for color Measurement Committee of the Society of Dyers and colorists). The CMC formula was published in 1984.

The "components" of  $dE$ , namely  $dL$ ,  $dC$  and  $dH$ , are weighted with correction factors  $S_L$ ,  $S_C$  and  $S_H$ , which themselves in turn are dependent on the lightness, colorfulness and hue.  $S_L$ ,  $S_C$  and  $S_H$  are essentially hyperbolic functions, ensuring that  $dL$  and  $dC$  increase as the colors become darker and more achromatic (greyer).  $dH$  also decreases as the chroma increases. A correction is also made depending on the situation of the color circle.

The CMC color distance formula is as follows:

$$dE_{CMC} = \sqrt{\left(\frac{dL^*}{S_L}\right)^2 + \left(\frac{dC^*}{S_C}\right)^2 + \left(\frac{dH^*}{S_H}\right)^2}$$

**L** lightness factor

**c** chroma factor

$S_L$  function of L

$S_C$  function of C

$S_H$  function of H and C

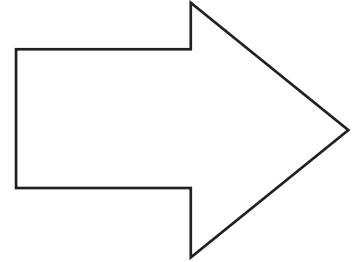

Valid for  $S_L$ :

$$\text{If } L^* < 16 \quad S_L = 0.511$$

$$\text{If } L^* \geq 16$$

This correction improves the evaluation of  $dL$  values by almost 200% in the case of very dark color!

Valid for  $S_C$ :

$$S_L = \frac{0.040975L^*}{1 + 0.01765L^*}$$

$$S_C = \frac{0.0638C^*}{1 + 0.0131C^*}$$

With the parameter  $S_C + dC$  values close to the achromatic axis are weighted approx. 60% more highly. For brilliant colors (high chroma values), CMC decreases existing DC values.

Valid for  $S_H$ :

$$S_H = (FT + 1 - F) S_C$$

$$\text{where } F = \sqrt{\frac{C^*4}{C^*4 + 1900}}$$

$$\text{And } T = 0.36 + |0.4 \cos(35 + h)|$$

$$\text{unless } 164^\circ < h < 345^\circ$$

$$\text{Or } T = 0.56 + |0.2 \cos(168 + h)|$$

Note: | represents an absolute value

Due to the influence of  $S_C$ , given  $dH$  values close to the achromatic axis are weighted more highly, but not as highly as with  $S_C$  alone, due to the influence of the factor  $f$ . According to the CMC formula,  $dH$  increases in the orange area and in the violet area, and decreases in the green to blue area and in the purple to red area.

The principle of CMC acceptability

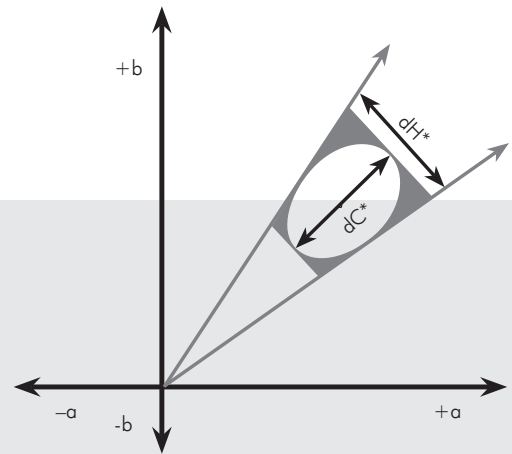
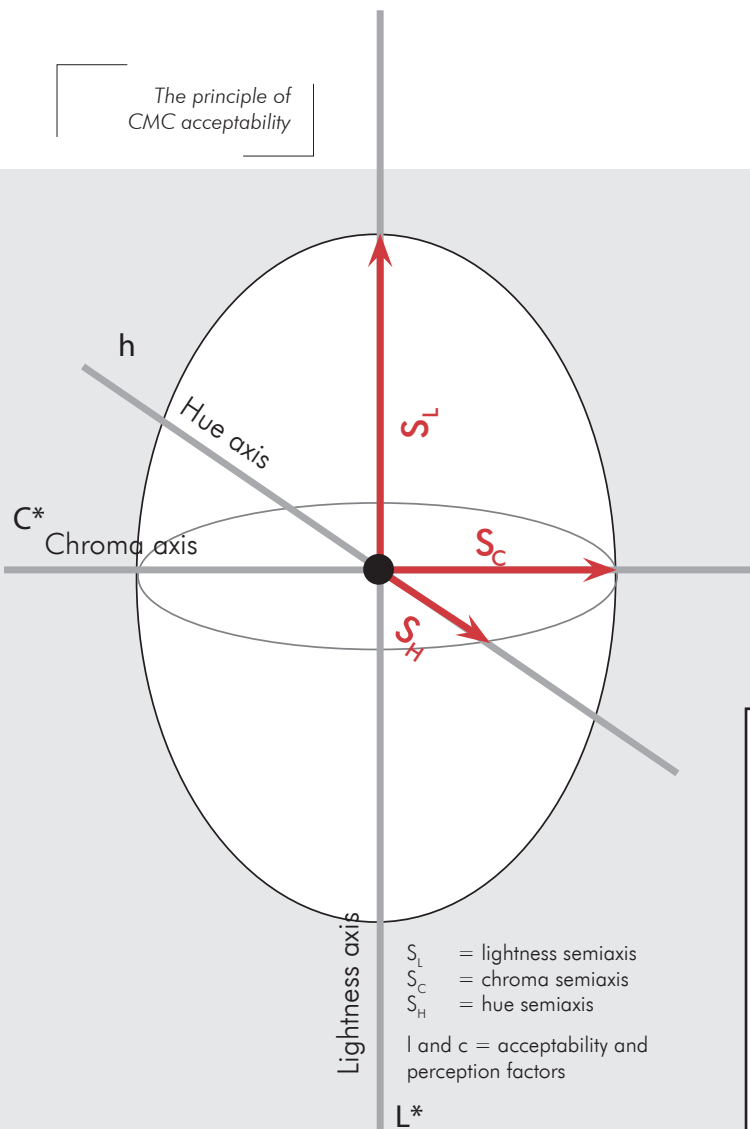

$$dE_{CMC} = \sqrt{\left(\frac{dL^*}{l S_L}\right)^2 + \left(\frac{dC^*}{c S_C}\right)^2 + \left(\frac{dH^*}{S_H}\right)^2}$$

CMC - tolerance = ellipsoid

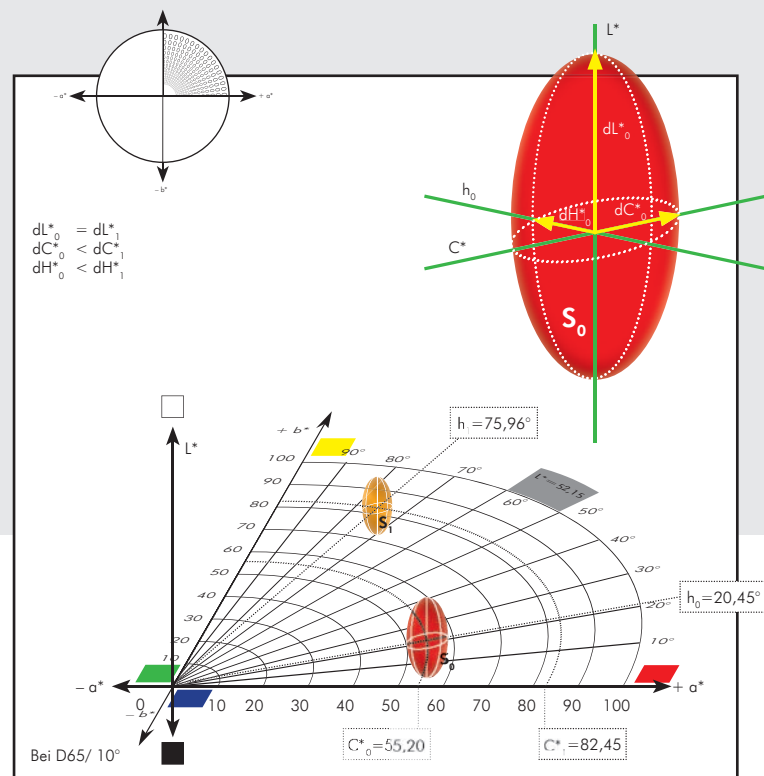

CMC acceptability tolerances in the CIELAB color space

The CMC color distance formula is based on approximately 2,000 textile samples that were matched under D65 illumination and measured using the CIE64 10° standard observer function.

The correction parameters ( $S_L - S_C - S_H$ ) have therefore been empirically evaluated and are available in formulae that allow prior calculation. Furthermore, the two additional factors l ("lightness") and c ("chroma") can influence the results depending on how a problem – especially the acceptability of a deviation – is positioned.

The correction parameters l and c can be changed by the user. They are both equal to 1. This corresponds to the most common case when evaluating the perceptibility of color deviations. In order to evaluate the acceptability, the values l and c can be increased or decreased. For example, the CMC combination (2,1) is used in the textile industry, where l = 2 and c = 1. Here, l = 2 means that only half of the lightness distance goes into the calculation for the total color distance.

The lightness difference ( $dL^*$ ) is changed only via the lightness. It increases for lower lightness values and

decreases for higher lightness values.

The differences in colorfulness ( $dC^*$ ) are changed only via the colorfulness. They are generally smaller compared with the CIELAB system, with the exception of low values of colorfulness, smaller than 6.

The hue deviations ( $dH^*$ ) are changed only via the hue angle and the colorfulness. It can be seen, especially for orange shades, that the color deviations become larger in relation to the green shades, and that the effect of the color deviations with reference to the CIELAB system reduces considerably if colors are relatively saturated.

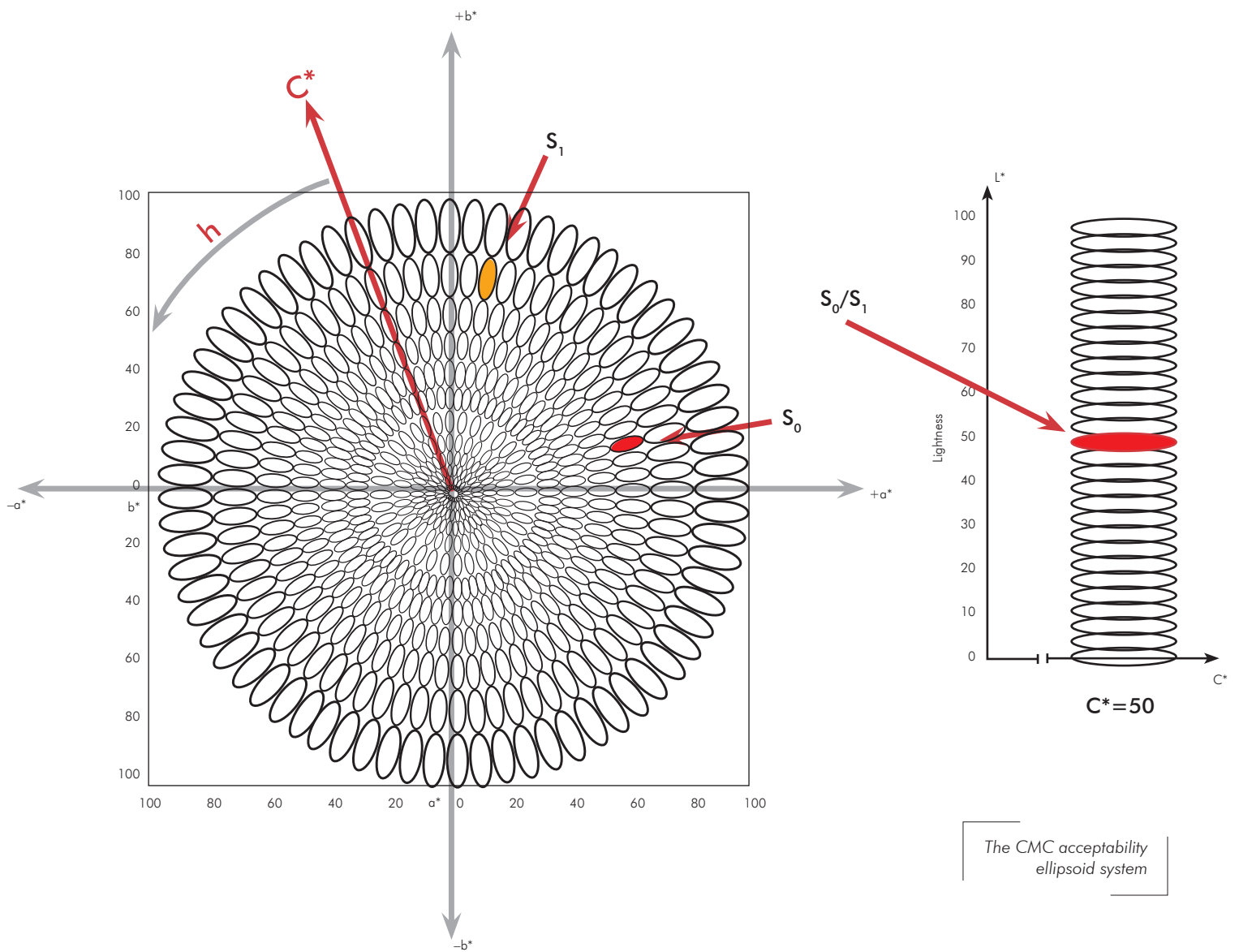

The effects of these correction parameters can be seen in the above graphic. The visually determined differences of the same magnitude are specified as ellipses for the area  $a^*/b^*$  for a constant lightness. The differences within an ellipse are perceived by the human eye as equal. The right-hand side of the graphic shows the acceptability ellipses on the  $L^*$  axis (for a constant colorfulness  $C^* = 50$ , but a variable lightness  $L^*$  of 0 -100).

The graphic makes one thing clear: The CMC formula does not provide a uniform representation system or form a color space, but it enables the calculation of color deviations and acceptability based on an empirical valuation of any color point in the CIELAB color space.

In the context of improving the acceptability formulae and the color distances, the CIE developed the color distance formulae CIE94 and CIE2000.



## The CIE94 color distance formula

In 1994, the CIE published the CIE94 color distance formula. It is based on a similar approach to the CMC formula, but provides three correction parameters ( $k_L$ ,  $k_C$  and  $k_H$ ) that can be optimised according to the application area. Observation conditions have also been added to the formula, which serve as a basis for the presentation and observation of the samples.

The CIE94 color distance formula is as follows:

$$dE_{94} = \sqrt{\left(\frac{L_2^* - L_1^*}{k_L S_L}\right)^2 + \left(\frac{C_2^* - C_1^*}{k_C S_C}\right)^2 + \left(\frac{dH_{ab}^*}{k_H S_H}\right)^2}$$

$$L_2^* - L_1^* = dL^*$$

The total color distance  $dE_{94}^*$  between 2 color samples represents the distance in the CIELAB color space (CIELAB) that has been weighted and adjusted by the user. Under specified reference conditions, the formula takes into account the components of these color distances, such as the differences in lightness ( $dL^*$ ), the difference in colorfulness ( $dC^*$ ), and the hue difference ( $dH^*$ ).

The factors  $S_L$ ,  $S_C$  and  $S_H$  represent the respective weighting factors for the differences in lightness, colorfulness and hue. They are calculated and weighted as follows:

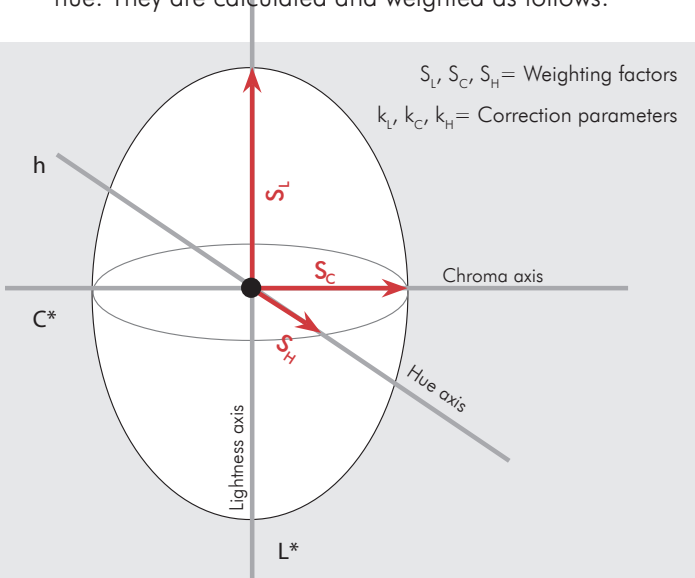

$$dE_{94} = \sqrt{\left(\frac{L_2^* - L_1^*}{k_L S_L}\right)^2 + \left(\frac{C_2^* - C_1^*}{k_C S_C}\right)^2 + \left(\frac{dH_{ab}^*}{k_H S_H}\right)^2}$$

CIE94 Color distance formula

The factors  $k_L$ ,  $k_C$  and  $k_H$  are correction parameters that are linked with the observation conditions of the samples. The reference conditions are determined experimentally as typical conditions for the observation of control colors.

$$\begin{aligned} S_L &= 1 \\ S_C &= 1 + 0.045 C^* \\ S_H &= 1 + 0.0015 C^* \end{aligned}$$

### The reference conditions:

- Illumination – light source: the light source simulates the D65 standard illuminant type, which is the equivalent of daylight
- Illumination of the sample with a light intensity of approximately 1000 lux
- Environment: uniform observation background of a neutral grey color and lightness  $L^* = 50$
- The surfaces to be observed (samples) must fulfil the following conditions as far as possible:
  - Observation field and distance must be illuminated so that the field of vision is greater than the centrally fixed field of vision of  $4^\circ$
  - The samples must be arranged next to one other; they cannot be separated and must be in direct contact so that the separating line is not apparent, as far as possible.
  - The structure, texture and color must be as uniform as possible.

### Note:

The correction factors  $k_L$ ,  $k_C$  and  $k_H$  are still valued very badly for special prerequisites. The correction factors  $k_L$ ,  $k_C$  and  $k_H$  are equal to 1 for the reference conditions. In the textile industry, the following factors are generally used:  $k_L = 2$  and  $k_C = k_H = 1$ .

The CIE color distance formula must be expressed in the form of  $dE_{94}^*$  and written using the abbreviation CIE94. The correction parameters  $k_L$ ,  $k_C$  and  $k_H$  do not have to equal 1. In this event, they must follow the abbreviation  $dE_{94}^*$ . An example from the textile industry: for the factors  $k_L = 2$  and  $k_C = k_H = 1$ , the notation is then CIE94 (2:1:1) with the symbol  $dE_{94}^*$  (2:1:1).

Tolerance diagram CIE94

## CIE2000 – the current CIE color distance formula

Even though it was an improvement on the CMC formula, CIE94 achieved little or no acceptance in the industry. Therefore, it was refined using new data sets and replaced by the new formula CIE2000. The CIE2000 color distance formula is the formula that

currently best matches visual perception. It contains not only weighting functions for lightness, colorfulness and hue, but also mixing terms. These terms take into account additional dependency of the colorfulness on the hue.

The CIE2000 color distance formula is as follows:

$$dE_{00} = \sqrt{\left(\frac{dL^*}{k_L S_L}\right)^2 + \left(\frac{dC^*}{k_C S_C}\right)^2 + \left(\frac{dH^*}{k_H S_H}\right)^2 + R_T \left(\frac{dC^*}{k_C S_C}\right)\left(\frac{dH^*}{k_H S_H}\right)}$$

The last term in the equation is also referred to as a rotation term. This introduces an additional weighting dependent on the “rotating” hue, and should correct particularly bad cases of lack of equivalence between visually perceived and calculated color distances in the blue color range.

All of the color distance formulae described up until now can be represented by means of the above equation. Thus, for CIE94 and CMC,  $S_L = 1$ . The rotation term does not exist for the color distance formulae CMC and CIE94, so therefore it is zero ( $R_T=0$ ).

CIE2000 gets very close to the goal of obtaining an equivalent color distance for all shades of color.

### Assessment of CMC, CIE94 and CIE2000 in summary

All of the corrections to the original CIELAB dE formula represent a significant improvement to color difference evaluation. However, as long as no DIN or ISO standards exist, no corrected dE formulae will gain acceptance in practice. Therefore, the technical standards committee for color in the DIN (especially working committee 4), in parallel with the development of the CIE (CIE2000), had the idea of transforming the entire color space to make the scale more uniform instead of modifying the color distance formulae themselves. The result was a new color coordinate system, which subsequently defined a color space that had a uniform chromaticity scale for small color distances. As color distances can now be calculated as vector length from the differences of the color coordinates (here  $L_{99}$ ,  $a_{99}$  and  $b_{99}$ ), this is referred to as a “Euclidean color space”. The relevant formula was introduced in 1999 as the DIN 99 formula.

### Relative color differences – comparison of differently calculated color distances

		L*	a*	b*	C* <sub>ab</sub>	dE* <sub>ab</sub>	dE <sub>94</sub>	dE <sub>00</sub>	dE <sub>99</sub>
Cyan (C)	1	54	-37	-50	62.2	6.00	3.54	2.29	2.16
	2	52	-41	-46	61.6				
Magenta (M)	1	47	75	-6	75.2	6.00	2.94	2.66	2.54
	2	45	79	-2	79.0				
Yellow(Y)	1	88	-6	95	95.2	6.00	2.77	2.69	2.54
	2	86	-10	91	91.5				
Black	1	18	0	-1	1.0	6.00	5.78	6.28	4.76
	2	16	4	-5	6.4				
C+M	1	26	22	-45	50.1	6.00	3.73	4.56	3.97
	2	24	26	-41	48.5				
C+Y	1	49	-65	30	71.6	6.00	3.26	2.97	2.83
	2	47	-69	26	73.7				
M+Y	1	48	65	45	79.1	6.00	3.23	3.48	2.59
	2	46	69	41	80.3				
Paper	1	93	0	-3	3.0	6.00	5.45	6.13	4.09
	2	91	4	-7	8.1				

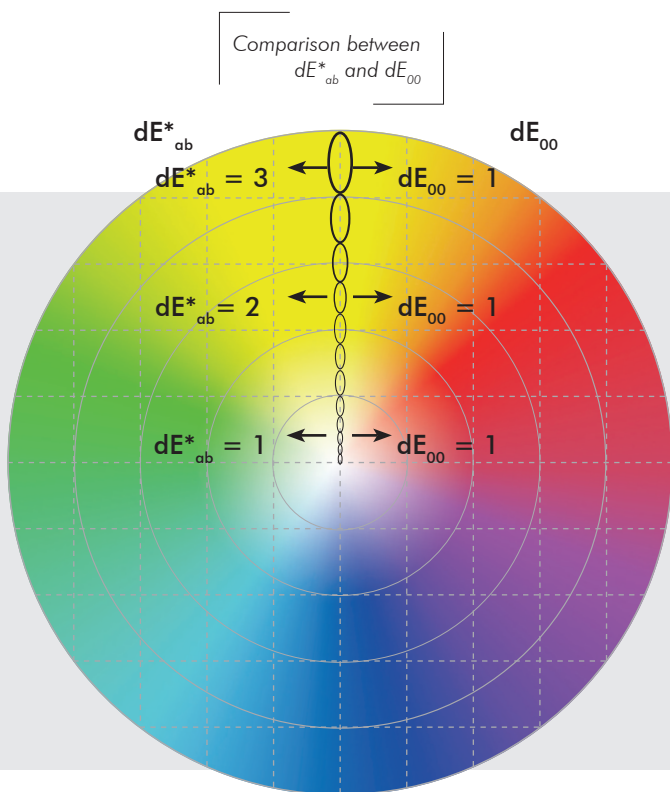

## The DIN 99 color space

The basis for the DIN 99 color space is the CIELAB color space with its coordinates  $L^*$ ,  $a^*$ ,  $b^*$ .

The transformation from CIELAB to DIN 99 took place in two parts: A transformation of lightness to the new DIN 99 lightness  $L_{99}$ , and a transformation of colorfulness or chroma.

After the transformations, the values such as chroma ( $C_{99}$ ), hue angle ( $h_{99}$ ) and color distance ( $dE_{99}$ ) can then be calculated.

The DIN 99 formula is designed for small to medium color distances. Its application is recommended for small color distances up to 5 dE CIEL<sub>ab</sub> such as those dealt with in quality assurance and recipe calculation.

### Calculation

#### Lightness transformation

The lightness  $L^*$  is transformed to the DIN 99 lightness  $L_{99}$ :

$$L_{99} = \left( \frac{1}{k_E} \right) \cdot (105.51 \cdot \ln(1 + 0.0158 \cdot L^*))$$

This transformation is to better reproduce the distinguishability of darker shades of color. The area for the dark shades of color is expanded and the area for the light shades is compressed. Medium lightness values are shifted upwards on the lightness axis.

The variable  $k_E$  describes the influence of changed observation conditions.

Under reference conditions,  $k_E = 1$ .

#### Colorfulness transformation

The transformation of the colorfulness coordinates takes place in three steps:

- The colorfulness axis is rotated by  $16^\circ$
- The yellow/blue axis is multiplied by the factor 0.7, and is therefore compressed
- The colorfulness (chroma) values are logarithmically compressed radially around the  $L_{99}$  axis

Unlike in the CIE2000 formulae, it is not necessary to determine the hue angle in order to calculate the color distance.

Starting situation:  $a^*/b^*$  plane. The points in these and the following illustrations represent each set of  $a^*/b^*$  coordinates going from -150 to 150 in steps of ten

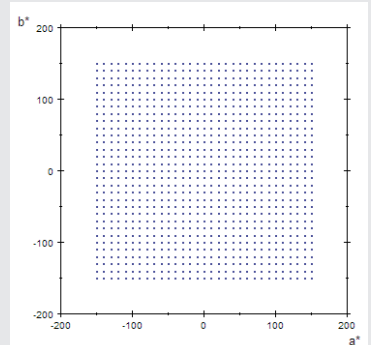

Step 1: rotation of the  $a^*/b^*$  plane by  $16^\circ$

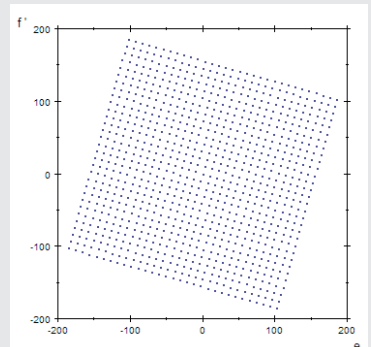

Step 2: compression of the  $f$  axis

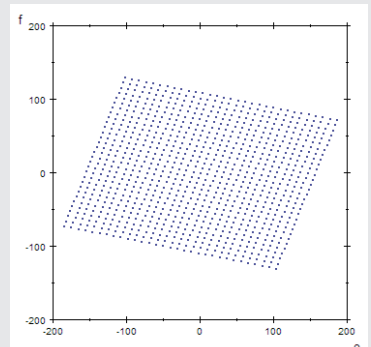

Step 3: radial compression of the  $e/f$  plane

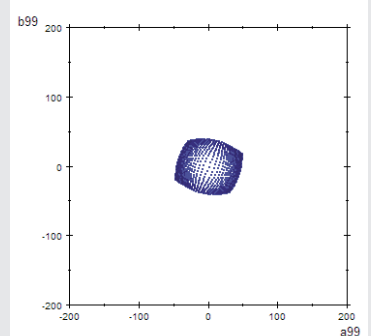

Enlarged view of the  $a_{99}/b_{99}$  plane

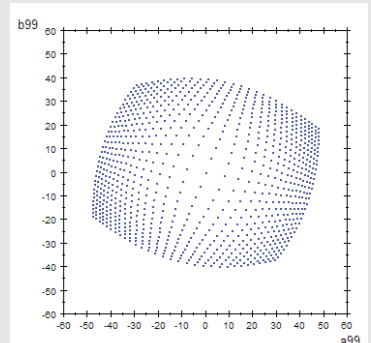

The individual calculations are as follows:

$a^*$  and  $b^*$  are transformed to:

Redness values (red/green axis)

$$e = (a^* \cdot \cos(16^\circ) + b^* \cdot \sin(16^\circ))$$

Yellowness value  $f$  (yellow/blue axis)

$$f = 0,7 \cdot (-a^* \cdot \sin(16^\circ) + b^* \cdot \cos(16^\circ))$$

From this, the chroma value  $G$  (colorfulness) is then calculated:

$$G = \sqrt{e^2 + f^2}$$

With the compression factor

$$k = \frac{\ln(1 + 0.045 \cdot G)}{(k_{CH} \cdot k_E \cdot 0.045)}$$

this results in the

hue values

$$a_{99} = k \cdot \frac{e}{G}$$

$$b_{99} = k \cdot \frac{f}{G}$$

In the case that  $a^* = b^* = 0$ , also  $e = f = G = 0$ , then  $a_{99} = b_{99} = 0$ .

An advantage compared to the other correction methods is that with the transformed  $a_{99}$  and  $b_{99}$ , you can now proceed exactly as you do in CIELAB, to now calculate, for example, a  $C_{99}$  (corrected colorfulness/chroma) or a  $dH_{99}$  (corrected hue difference).

Accordingly, the formulae are then as follows:

$$dH_{99} = \frac{(a_{99B} \cdot b_{99P}) - (a_{99P} \cdot b_{99B})}{\sqrt{0,5 \cdot ((C_{99B} \cdot C_{99P}) + (a_{99B} \cdot a_{99P}) + (b_{99B} \cdot b_{99P}))}}$$

or

$$dE_{99} = \sqrt{(dL_{99})^2 + (da_{99})^2 + (db_{99})^2}$$

where

$$dE_{99} = \sqrt{(dL_{99})^2 + (dC_{99})^2 + (dH_{99})^2}$$

$$C_{99} = \sqrt{(a_{99})^2 + (b_{99})^2}$$

In the DIN 99 system,  $dC$  and  $dH$  are calculated exactly as in CIELAB. The index  $B$  stands for the reference or comparison sample, and  $P$  stands for the sample.

## Quality and further development

The DIN 99 color space is very close to the CIE94 color distance formula and has similar qualitative characteristics, also comparable with CMC(l:c). A great advantage as opposed to CIE94 is the permutability of the sample and comparison sample in the calculation, making the transformation completely and easily reversible.

The difference from CIELAB is that, with regard to the calculations, the equivalence with perceived color distances has been improved. The DIN 99 formula is handled the same way as the CIELAB formula.

The modification of the lightness axis and the higher weighting of the colors close to the achromatic axis by the compression of extremely saturated colors considerably improve the uniformity of perceived color distances.

The evaluation categories of lightness axis and hue axis (yellow/blue and red/green) have not changed in comparison with CIELAB. The calculation of the color distance as a simple Euclidean distance is a great advantage compared with CMC(l:c), CIE94 and CIE2000, for which the calculation is very complicated.

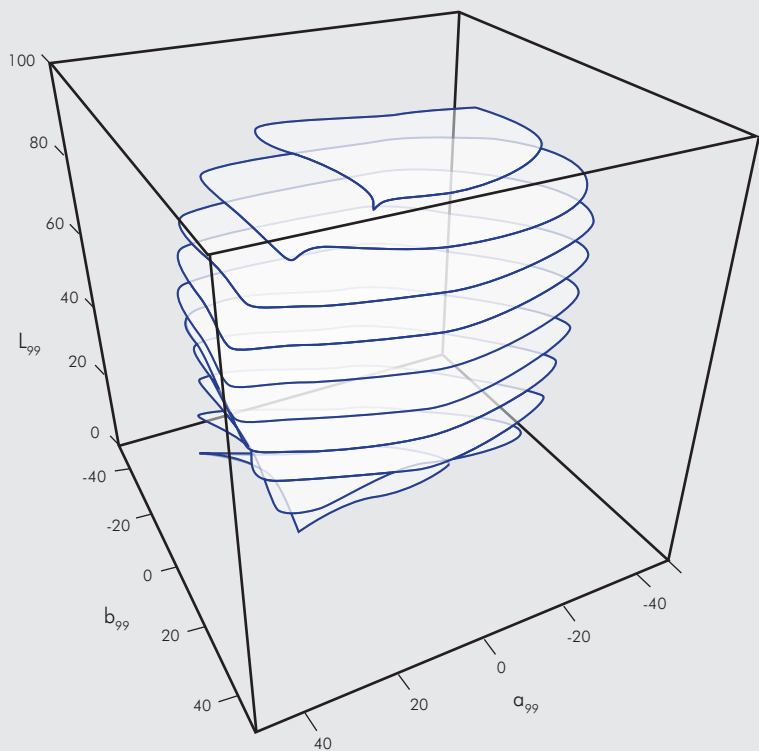

### Example of a modern color space:

DIN 99 optimal color solid in cross-sectional view. Sectional planes for lightness  $L_{99}=5$  to 95 in steps of ten.  $a_{99}$  represents the yellow/blue direction,  $b_{99}$  the red/green direction. Distortions come about because the connection of the colors with lightnesses is a factor in present-day color spaces. The area of this color solid is created via spectra. The area represents the entirety of all optimal colors (colors with the highest chroma and brilliance). The volume of the color solid represents all of the colors that are theoretically possible.

VISIBLE SPECTRUM

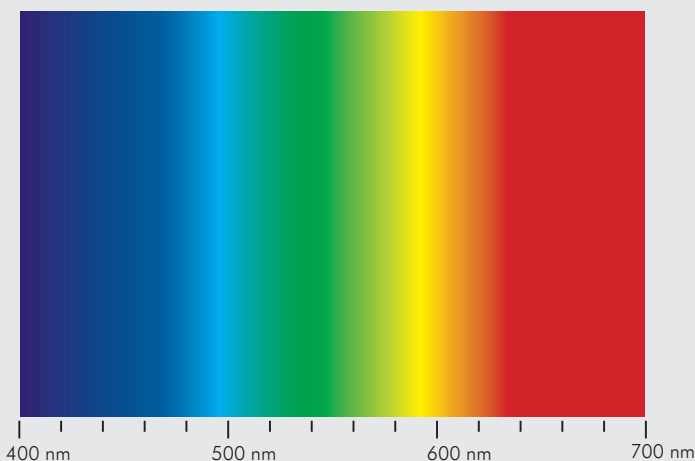

In 2017, DIN issued an improved version of DIN99 called DIN99o. The improvements were the following coefficient changes:

- For Redness and Yellowness, change  $16^\circ$  to  $26^\circ$ , and 0.7 to 0.83.
- For Chroma, change numerator 0.045 to 0.075, and denominator 0.045 to 0.0435.
- For Lightness, change 105.59 to 303.67 and 0.015 to 0.0039.

*DIN 99 optimal color  
solid – standard  
illuminant D65*

## Conclusion and outlook for the future

Instrumental color measurement is an essential aid to quality assurance in industry. It complements visual color matching and allows the introduction of numerical values as tolerances. Cooperative work between suppliers and customers is thus put on a reproducible basis, with both sides using technical measurement. It is important, however, that the colorimetric assessments match the visual assessment as far as possible.

The color spaces developed over the years now come very close to visual color perception, but also display weaknesses, as the color distance perceived visually in many cases does not correspond with the parameter for the measured color distance,  $dE^*$ .

Further work is constantly being carried out on the development of a completely uniform color space, on a formula for color distance, and on simple acceptability that is representative of visual perception. Research in recent years on the neurophysiology of vision and psychology of perception, together with statistical research, is also leading to improved efficiency of acceptability formulae and making their automatic usage ever more reliable. It can therefore be said in good conscience that with perfect command and expert handling of the current mathematical model calculations in the area of the objective automatic control of colors and color distances, color measurement can today be applied accurately to guarantee high quality of the colored products.

## Metamerism

Metamerism is a characteristic of a pair of samples. Two samples match when viewed by a specific observer under a specific lamp. However, when either the lamp or observer changes, the colors no longer appear to match. The choice of colorants in the recipe influences the degree of metamerism between the samples. Computer color matching systems include settings to select the least metameric formula available to match a color. The formula selected may be the best match to the color under a variety of lighting and viewing conditions, and you may not be able to visually detect the metamerism between the samples when you change either condition.

When you use the same ingredients in the original sample to match a color, you can match the spectral curve of the object, wavelength by wavelength. However, this is not necessary to reproduce a color. In commercial applications, it is standard practice to match the colorimetric description of a particular color. You find a formula that matches the tristimulus values of a color for a specific lighting and viewing condition. To do this you do not have to have the exact colorants used to make the target color. You may find several different recipes to match the color. However, keep in mind that changing the lighting or viewing conditions, changes the colorimetric description of the color. When you match the tristimulus values, if you change either condition the colors may no longer match.



### Metamerism

Standard specifications (X-Y-Z) for the 10° -normal observer

	Illuminant type D65 (Daylight)		Illuminant type A (Artificial light)	
	Standard STD.N	Sample No. 2 ECH2.N	Standard STD.N	Sample No. 2 ECH2.N
X	X <sub>0D</sub> = 31.28	X <sub>2D</sub> = 31.28	X <sub>0A</sub> = 47.88	X <sub>2A</sub> = 52.66
Y	Y <sub>0D</sub> = 20.28	Y <sub>2D</sub> = 20.28	Y <sub>0A</sub> = 27.57	Y <sub>2A</sub> = 31.41
Z	Z <sub>0D</sub> = 12.71	Z <sub>2D</sub> = 12.71	Z <sub>0A</sub> = 4.04	Z <sub>2A</sub> = 4.42

Color-matching functions

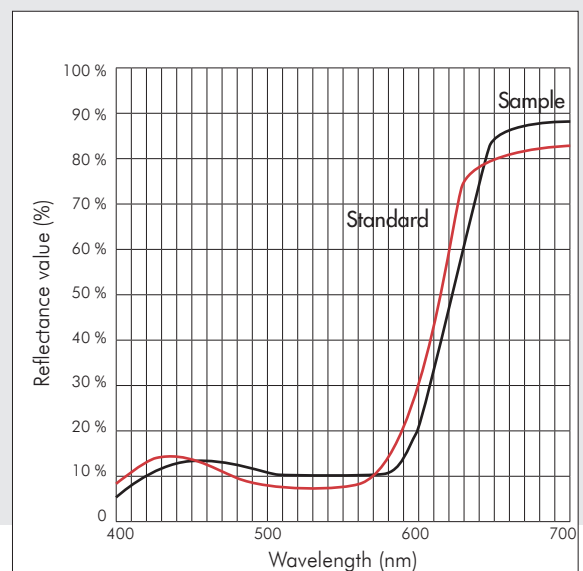

## List of references

- Farbe sehen, Corinna Watschke, 01.2009 [www.planet-wissen.de],
- Farbmanagement in der Digitalfotografie (ISBN 3-8266-1645-6), 2006, Redline GmbH, Heidelberg
- Beschreibung und Ordnung von Farben, Farbmeterik, Farbmodelle, DMA Digital Media for Artists – Archiv 2006-2011, Kunstuniversität Linz, Gerhard Funk
- Messen – Kontrollieren – Rezeptieren, Dr. Ludwig Gall [www.farbmeterik-gall.de]
- Farbabstandsformeln, 2012, Fogra Forschungsgesellschaft Druck e.V. [www.fogra.org]
- Wikipedia, diverse Artikel über Farbe und Farbmessung [http://de.wikipedia.org/wiki/Farbe]
- Verschiedene Darstellungen von Farbmodellen und Farbräumen [http://www.chemie-schule.de/chemieWiki\_120]
- Praktische Farbmessung, Anni Berger-Schunn, 2. überarbeitete Auflage, 1994, Muster-Schmidt Verlag, Göttingen – Zürich
- Farbabstandsformeln in der Praxis, SIP 01.2011
- Schläpfer, K.: Farbmeterik in der grafischen Industrie, 3. Aufl. St. Gallen; UGRA 2002 (Tabelle S. 48)

## Publication Data

### Publisher:

Datacolor, Inc. 5 Princess Road, Lawrenceville, NJ 08648, USA  
Telephone: 1-800-982-6497 | Fax: 609-895-7472 | Marketing@datacolor.com | www.datacolor.com

### Text:

Gabriele Hiller, Hiller Direct Marketing, Stühren 41, 27211 Bassum, Germany  
www.hiller-direct-marketing.de

January, 2023

### EUROPE

Datacolor AG Europe  
6343 Rotkreuz  
Phone: +41 44.835.3800

### AMERICA

Datacolor Headquarters  
Lawrenceville, NJ  
Phone: +1 609.924.2189

### ASIA

Datacolor Asia Pacific Limited  
Hong Kong  
Phone +852 24208283

© Datacolor. All rights reserved. www.datacolor.com



[www.datacolor.com](http://www.datacolor.com)

Committed to the highest performance and quality. Certified to ISO 9001:2015 and ISO/IEC 17025:2017 in manufacturing centres, worldwide. © Datacolor. Datacolor and other Datacolor product trademarks are the property of Datacolor.